

Orientalmotor

Brushless Motors

BLV Series R Type

Modular Automation Compatible Products

**Battery-Operated, Compact, and Lightweight
Brushless Motors in the Era of Advancing
Automation**



NEW

60 W/100 W/200 W/400 W

DC Input

NEW

High-Power, Compact Brushless Motors. Developed to Support the Design of Compact, Battery Driven Automation.

- Output: 60 W, 100 W, 200 W, 400 W
- Power Supply Input: 24 - 48 VDC*1
- Electromagnetic Brake Type Also Available

*1 400 W type is 48 VDC

What are "Modular Automation Compatible Products"?

"Modular Automation Compatible Products" is a product group with a shared concept of battery-operated, compact, and lightweight. Optimal for self-propelled equipment, these products meet the needs of flexible automation lines and mobile automation.

Modbus (RTU)

CANopen



Driver



NEW CS Geared Motor

Compact, Lightweight, and High-Power Designed for Compact Equipment

- Compact and lightweight driver
When connected to a motor, recognizes the output and covers all output with a single driver.



- Transportation robots for flat, transportable masses can be designed

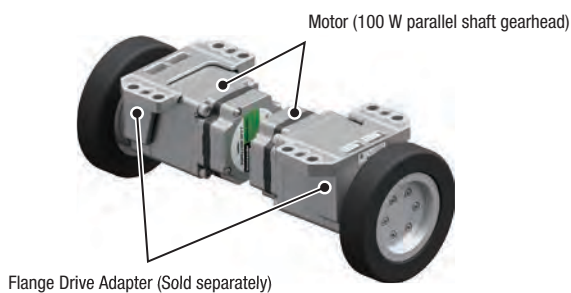

Compatible with Modbus (RTU) and CANopen Communication

- Unified controllability of transportation robots, conveyors and other mechanisms



• Conveyor Drive Motor (60 W CS geared motor)

Smooth Motion, Current Position Acquisition and Positioning Operation are Possible

A Wider Range of Operating Voltage Supports Real World Battery Use



Application: Autonomous transportation robot with belt conveyor

Various Applications

Transportation Robots

Transportation robots with a low floor design



Parallel Shaft Gearhead



Hollow Shaft Flat Gearhead

Support from Startup and Operation to Maintenance with the Support Software MEXE02

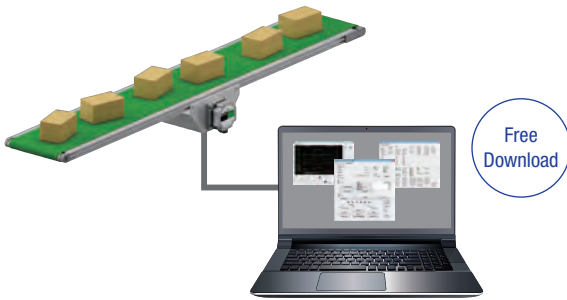

Support Software **MEXE02**

Agitators

Agitate at a stable speed, even if the viscosity (load) changes

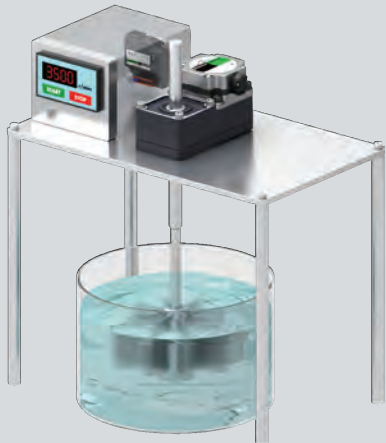

Conveyors

A broad range of speed control from low to high speed

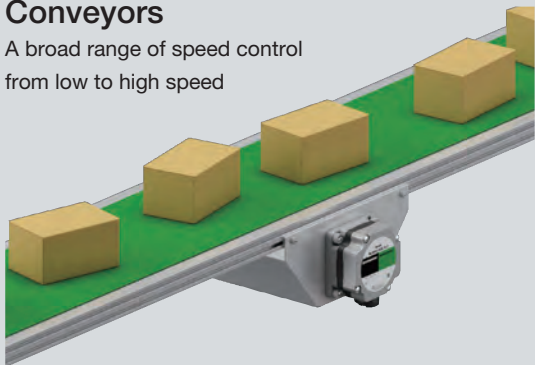

Simplified Main Program Thanks to Sequence Function

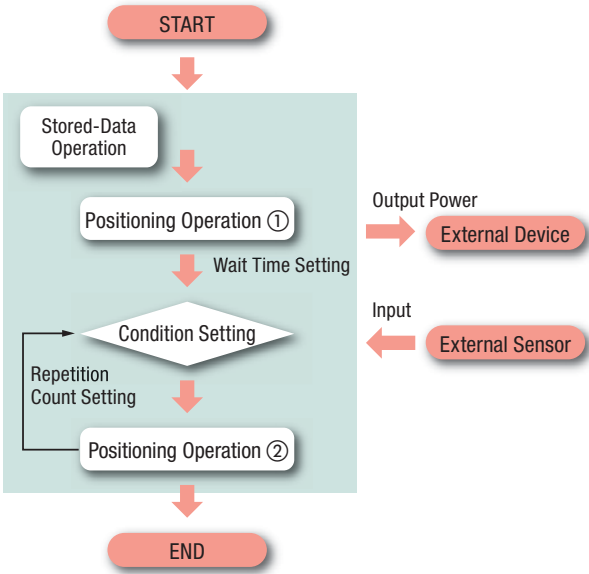

Security Cameras

Quiet drive
Compact driver



Designed for Compact Equipment

Compact and Lightweight

Both the motor and driver are significantly smaller and lighter.

The driver is approximately 80% smaller than the conventional product. The smaller driver saves valuable space in the automation equipment.

● Motor*

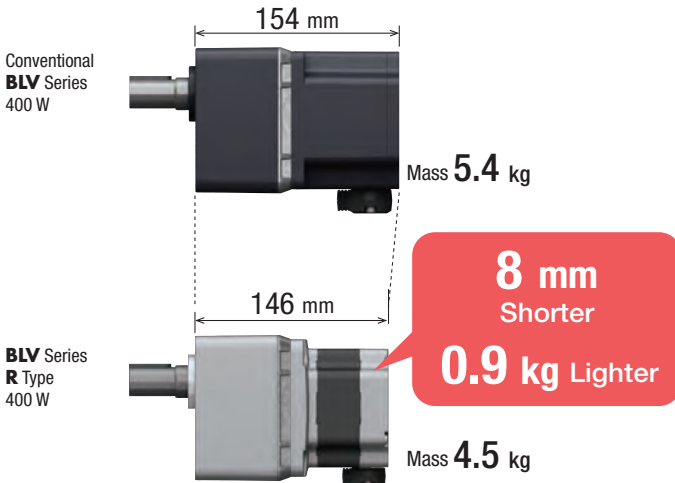

*For a 400 W parallel shaft gearhead at a gear ratio of 30

● Driver

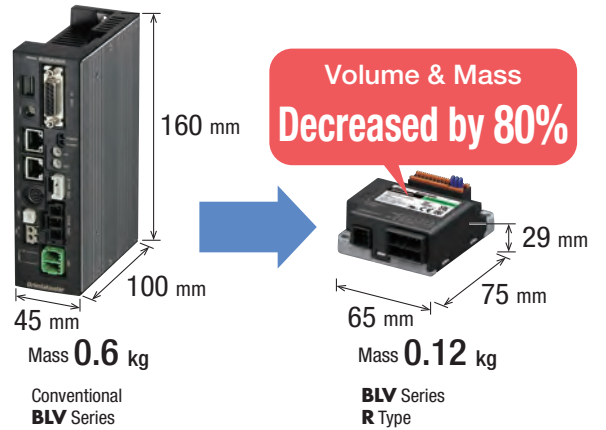

Powerful

The new motor allows for larger inertia loads and heavier products to be transported when compared to the conventional product. This also contributes to compact, high-power equipment design.

[Example of the design of a transportation robot]

● Conditions

BLV Series R Type Motor	Product Line	Hollow Shaft Flat Gearhead
	Output Power	400 W
	Gear Ratio	30
Driving Conditions	Vehicle Diameter	150 mm
	No. of Drive Wheels	2
	Acceleration Time	1 second



● Results

Max. Load Mass (Transportation robot mass + Load mass)	500 kg
Maximum Traveling Speed	0.7 m/sec

*The friction coefficient of the wheels is calculated at 0.1.



Wide Speed Range, Smooth Motion, Current Position and Position Feedback is Possible

Broad Speed Control Range of 1 - 4000 r/min

Smooth startup and stopping is possible thanks to stable operation even in the low speed range from 1 r/min.

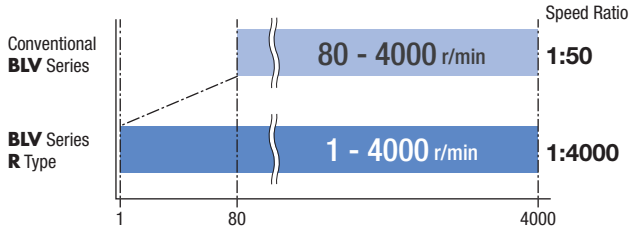

Benefit

•Smooth travel is possible, even with repeated start and stop operations.



High Speed Stability when Operated at High Speed

Operation at the set speed is possible even with the load fluctuation due to the speed regulation (load*1) of $\pm 0.01\%$.

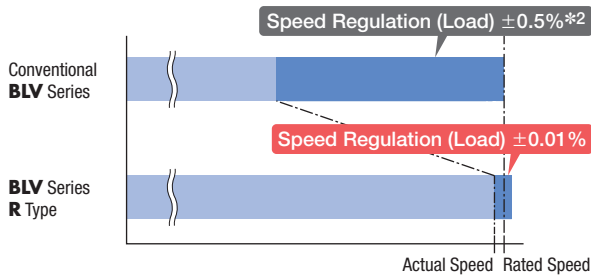

*1 Rate of change in speed when a constant load is applied

$$\text{Speed regulation} = \frac{\text{Actual speed} - \text{Command speed}}{\text{Command speed}} \times 100 (\%)$$

*2 $\pm 0.2\%$ for digital settings

Acquisition of Current Position and Positioning Operations are Possible

The current position can be acquired with enhanced motor feedback information. Improved resolution allows the motor to stop at the target position.

Improved Resolution Ensures
More Accurate Positioning Operations



●The stopping accuracy during positioning operation is $\pm 0.72^\circ$ on the motor shaft and around $1 - 2^\circ$ on the gearhead output shaft.

A Wider Range of Operating Voltage Supports Real World Battery Use

Wider Range of Operating Voltage

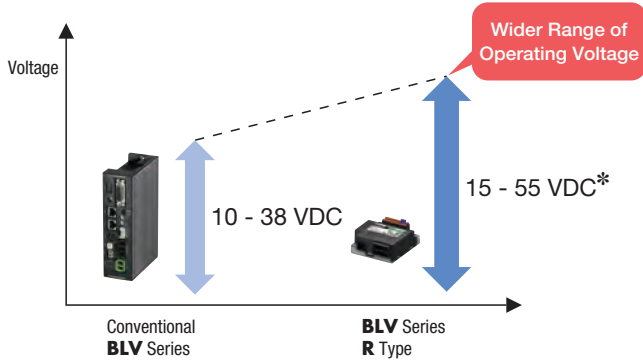

Benefit

- Compatible with 24 - 48 VDC batteries.
- Will not stop even if the battery voltage drops. Continues operating while limiting the speed and torque.
- The driver's overvoltage alarm threshold is 63 VDC.
- *400 W type is 48 VDC, operating voltage range is 30 - 55 VDC.

Power Consumption Reduced by 10%

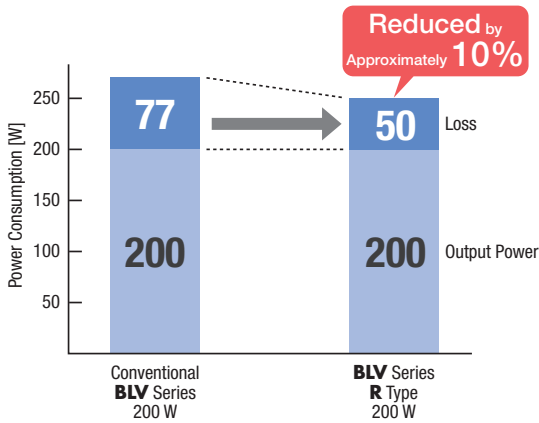

Benefit

- Extended travel distance and time for transportation robots. The number of battery charges can also be decreased.
- Power consumption can be monitored via the Support Software **MEXE02** and communication. This is useful as charging reference.

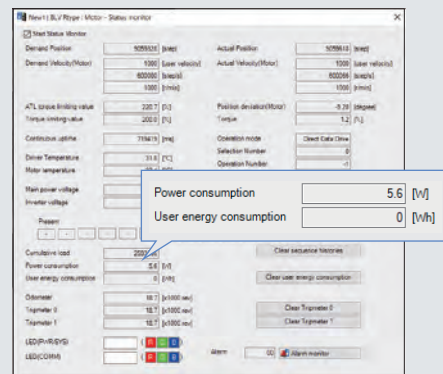

Various Recommended Functions

Holding when Stopped is Possible without an Electromagnetic Brake

When the motor has stopped in an excitation state, it can be used as an electrical holding brake, even without a mechanical brake. The motor enters an excitation state when the input signal "S-ON" is turned ON, and generates holding force. (Servo ON) When the input signal "PLOOP-MODE" is turned ON, the position can be held with no deviation from the stop position.

Note

If the power supply to the driver is turned OFF, the holding force dissipates. This cannot be used to prevent a fall during a power outage.

ATL Function that Automatically Limits Output Torque

The ATL function limits torque and ensures that the motor does not stop when an overload alarm occurs, even when torque continues to be output at a level at which an overload alarm is detected.

The motor will continue driving, even if an unexpected overload occurs*.

* Examples)

- Runs into an obstacle
- Sudden acceleration command
- Carrying a load exceeding the transportable mass

● Please disable the ATL function if the motor should stop when an alarm is output during overload.

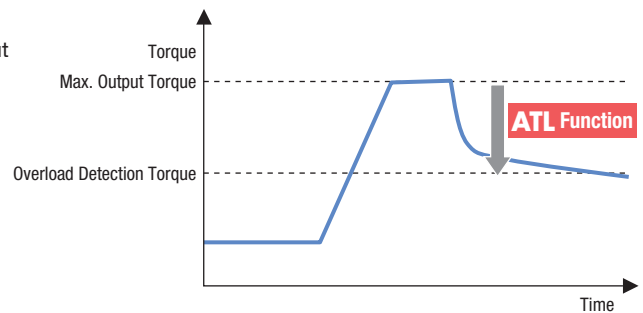

Simplified Main Program Thanks to Sequence Function

Can be used during stored-data operation, and comes with many sequence functions such as a timer setting for between operations and linked operation, conditional branching, and loop count. These help simplify the host system's sequence program.

- Stored-data settings (max. 256)
- Direct I/O (4 inputs, 2 outputs)
- Remote I/O (32 inputs, 32 outputs)

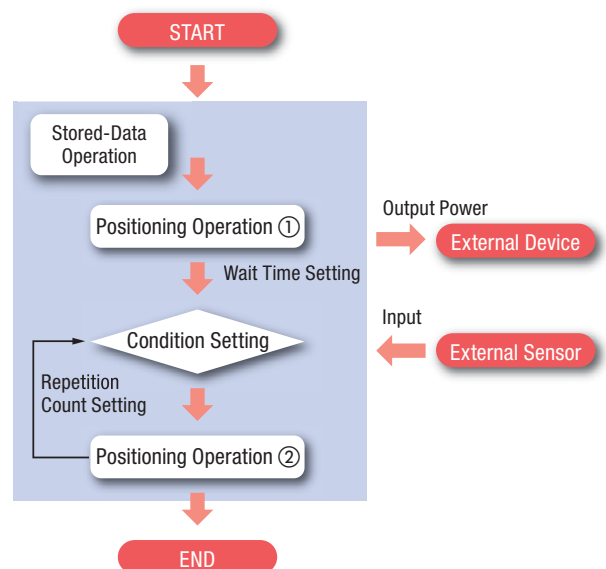
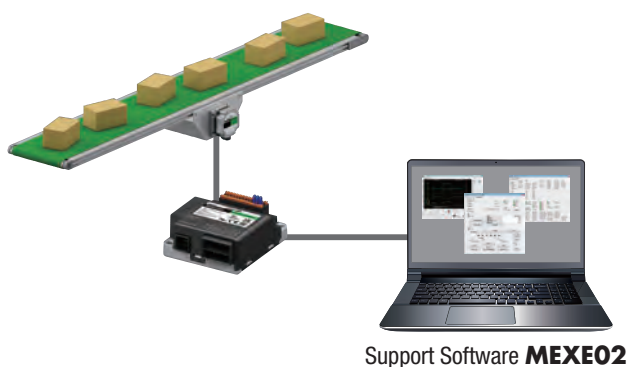

Compatible with Modbus (RTU) and CANopen Communication

The **BLV Series R** Type is compatible with the two interfaces of Modbus (RTU) and CANopen communication.

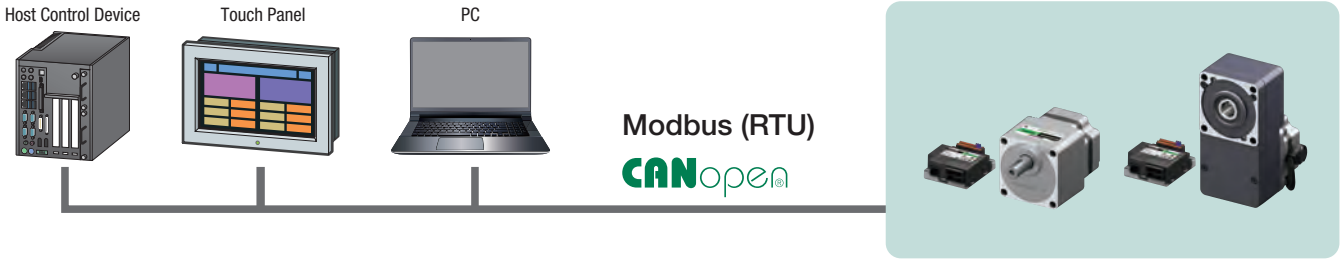

Main Functions with Modbus (RTU)

● Freely Create Operation Profiles - Direct Data Operation

With Modbus (RTU) communication, data can be rewritten and operations can be started at the same time.

● Types of Operating Data

Operating Modes	Sets the operating mode.
Position	Sets the target position.
Speed	Sets the operating speed.
Acceleration Rate	Sets the acceleration time.
Deceleration Rate	Sets the deceleration time.
Torque Limiting Value	Sets the torque limiting value.

● Gather, Send, and Receive Data Across Different Axes - ID Share Mode

This function improves synchronization between axes with Modbus (RTU) communication.

Data collected from multiple axes can be sent and received, shortening the communication delay between axes.

It can also be used to send different commands to each axis at the same time.

This transmission method is unique to Oriental Motor.

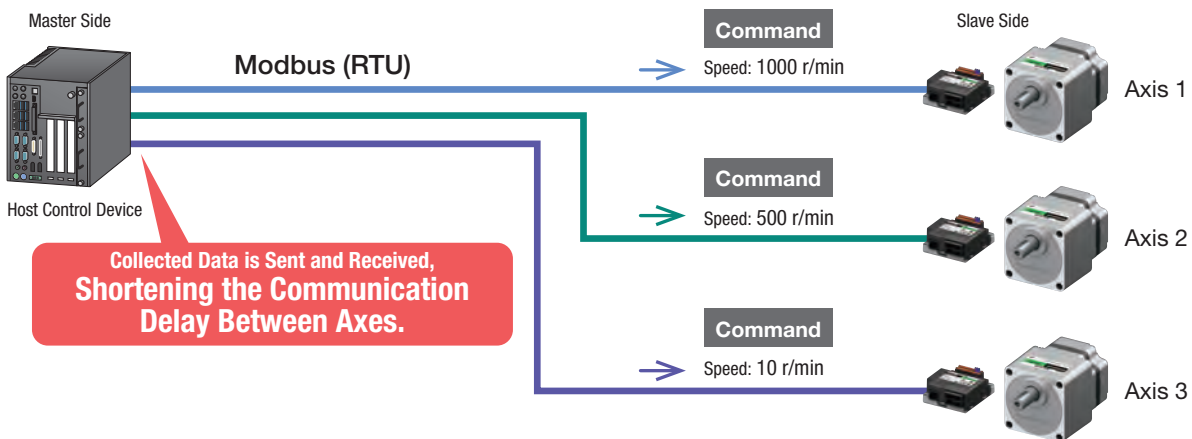

Support from Startup and Operation to Maintenance

with the Support Software **MEXE02**

By using the Support Software **MEXE02**, data setting, actual operation, and confirmation via each monitor can be performed easily on a computer. The support software can be downloaded for free from the Oriental Motor website.

→ https://www.orientalmotor.co.jp/download/software/mexe02_function/



Support Software
MEXE02

Startup Functions that Support Programming at Setup

● Simple Settings

Various communication settings can be easily made using the "Simple communication settings".

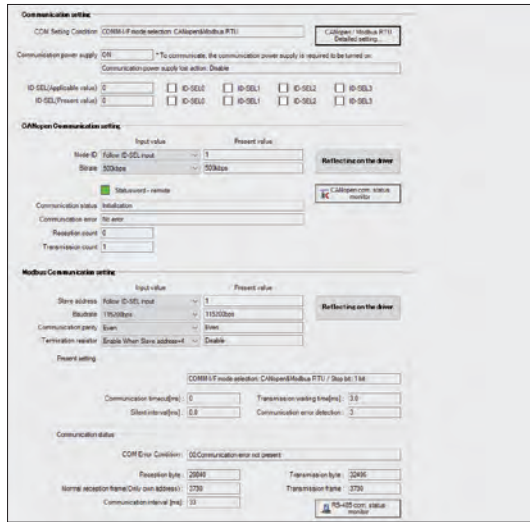

● Communication Frame Monitoring, Communication Status Monitoring

All communication frames and statuses can be monitored. This is useful for host program startup and debugging.

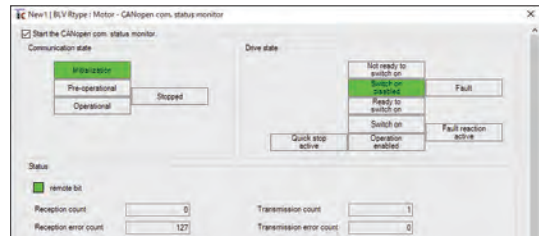
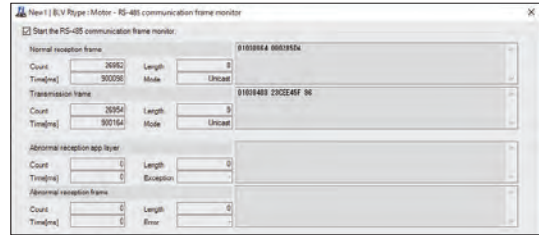

Operation Functions that Support Adjustments

● Waveform Monitoring

The operating status of the motor (command speed, torque, I/O signal, etc.) can be checked like an oscilloscope. Waveform measurement results can be saved as images and in CSV format.

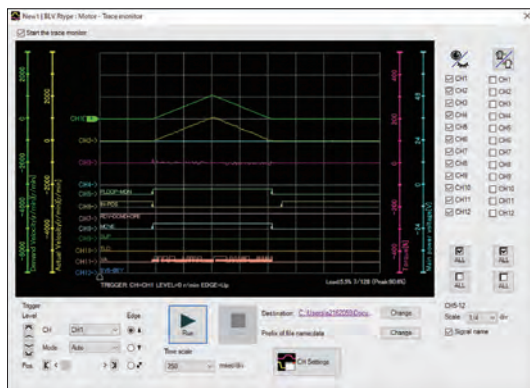

● FFT Monitoring

Visualizes mechanical resonance by analyzing frequency using FFT analysis. Noise and vibration can be reduced by adjusting the "Resonance suppression parameter".

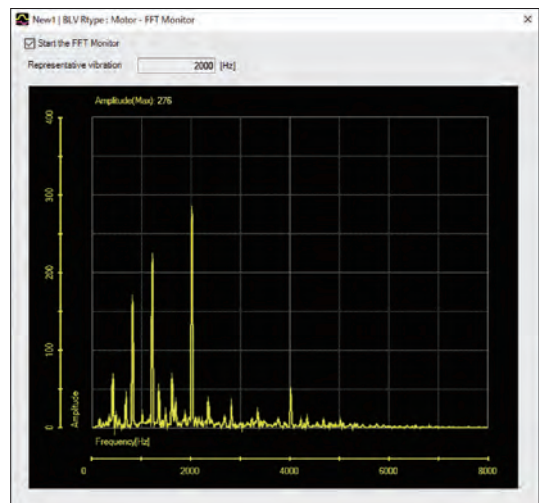

● Gain Tuning

Motor tracking can be adjusted according to the command.



Maintenance Functions that Support Diagnostics and Maintenance

Trace Monitoring

The operating status of the motor can be continuously measured for 24 hours or longer. Data can be saved in CSV format.

Merit

Data is saved for a long period of time, making it easy to determine the cause of a problem.



Various Monitoring Functions

The Support Software **MEXE02** can also monitor various other types of information. For details, please see the Oriental Motor website.

Gearheads that Contribute to Space Saving Design

Higher Torque and Space Saving are Achieved with a Hollow Shaft Flat Gearhead

Permissible Torque with no Saturation

No saturation of permissible torque even at high gear ratios. This is useful for maximizing the motor torque.

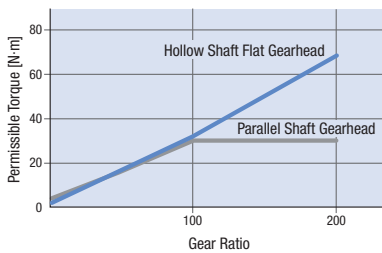

*When frame size is 90 mm

Space Saving and Cost Reduction

Direct connection to the drive shaft is possible without using a connecting part, which enables equipment space saving. The reduction in couplings, belts, pulleys, etc. also contributes to a decrease in the cost of parts and assembly work.

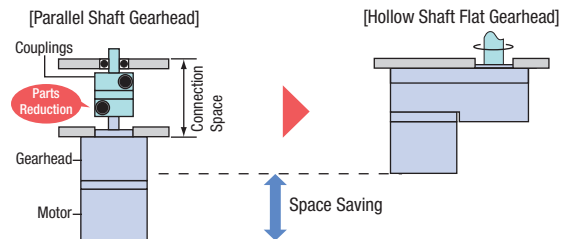

Example) Application in vehicle drive part Staggered for a compact configuration.

*Compatible with all types except 100 W

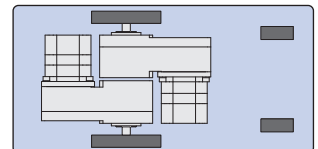

CS Geared Motor (60 W type) Makes Equipment Smaller and Lighter

CS geared motors feature increased load capacity, upgraded torque, and coaxial shaft.

Contributes to Space Saving and Lighter Equipment



Gear Structure with Coaxial Shaft



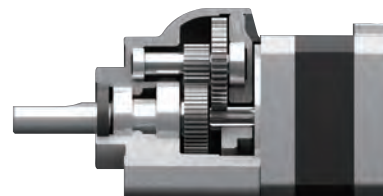

Large gears are arranged such that they will not escape from the central shaft, creating a gearhead with a coaxial shaft.



Product Line

Different motors, gearheads and cables are available based on the system requirements.

● Motors

Output Shaft Type	Output Power [W]	Frame Size [mm]	Gear Ratio	Electromagnetic Brake
Parallel Shaft Gearhead 	NEW 60	80	5 - 100	Not Equipped
	100	90	10 - 100	Equipped/ Not Equipped
	200	110		
	NEW 400		10 - 50	
Hollow Flat Gearhead 	NEW 60	80	5 - 200	Not Equipped
	100	90	10 - 200	Equipped/ Not Equipped
	200	104	10 - 100	
	NEW 400			
CS Geared Motor*1 	NEW 60	60	5 - 20	Not Equipped
Round Shaft Type 	NEW 60	60	-	Not Equipped
	100	90		Equipped/ Not Equipped
	200			
	NEW 400			

*1 A geared motor in which the motor and gearhead are integrated.

*2 0.3 m flexible connection cables are not available.

● 2 motor cable drawing directions to choose from



Cable Output in the Side of the Output Shaft



Cable Output in the Opposite Side of the Output Shaft

● Driver

	Power Supply Voltage [VDC]	Output Power [W]
	DC24 - 48	60 100 200
	DC48	400

● Connection Cables / Flexible Connection Cables

◇ 60 W **NEW**

	Length [m]
	0.3*2, 1, 2, 3

◇ 100 W/200 W/400 W

	Length [m]
	1, 2, 3

● Power Supply Cable

	Length [m]
	0.6

System Configuration

60 W

Motors, drivers, connection cables, and power supply cables are sold separately.

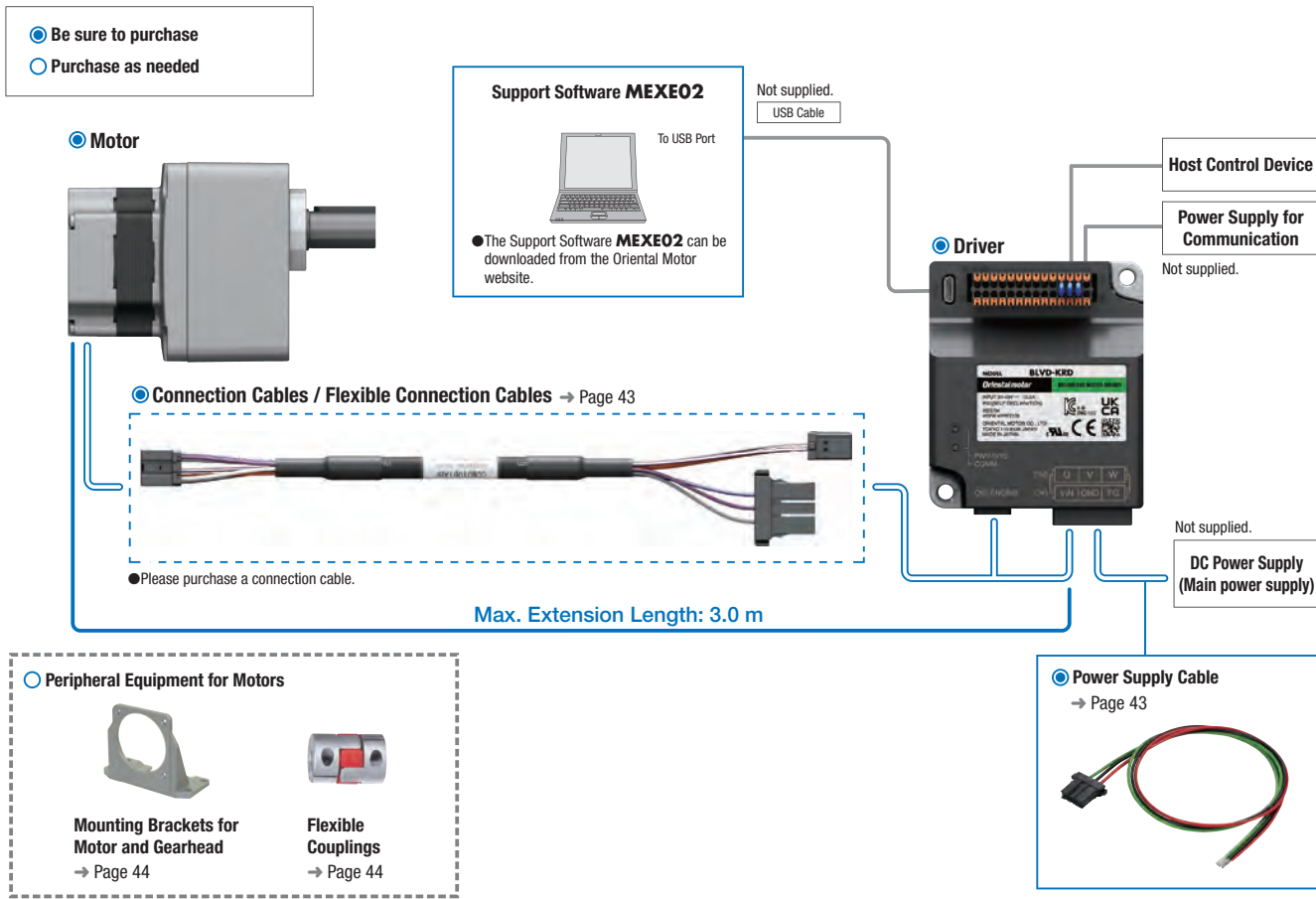

System Configuration Example

			Cables	
Motor	Driver	+	Connection Cable (1 m)	Power Supply Cable
BLMR460SHK-10	BLVD-KRD	+	CCM010B1ABF	LC03D06A
<input checked="" type="radio"/>	<input checked="" type="radio"/>		<input checked="" type="radio"/>	<input checked="" type="radio"/>

● The system configuration shown above is an example. Other combinations are also available.

● 100 W, 200 W, 400 W

Motors, drivers, connection cables, and power supply cables are sold separately.

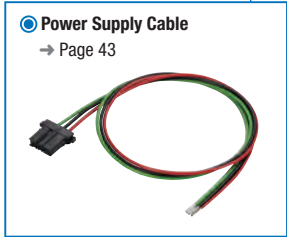
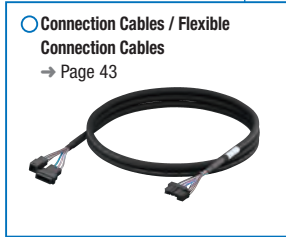
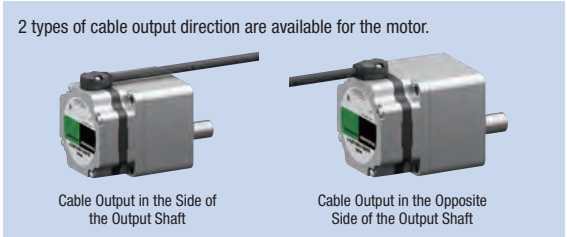
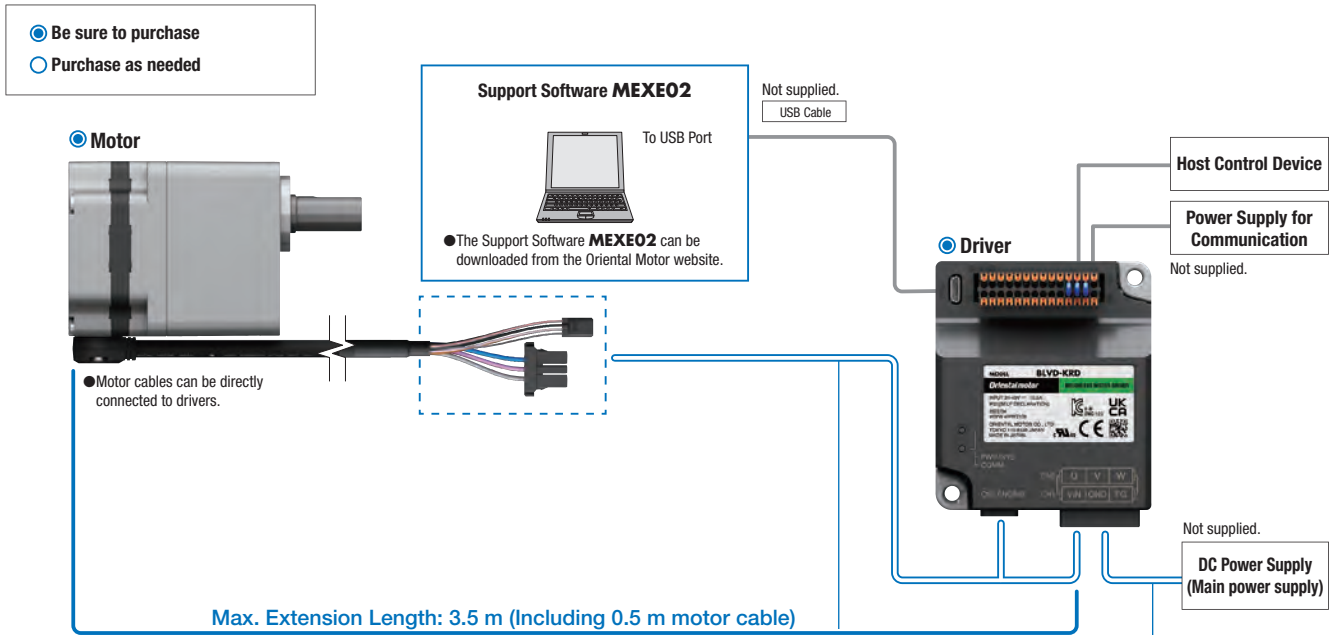

● System Configuration Example

			Cables	
Motor	Driver	+	Connection Cable (1 m)	Power Supply Cable
BLMR5100K-10-F	BLVD-KRD	+	CCM010B1AAF	LC03D06A
○	○	+	○	●

● The system configuration shown above is an example. Other combinations are also available.

Product Number

Motor

BLMR 6 200 S K M-10 FR-F

① ② ③ ④ ⑤ ⑥ ⑦ ⑧ ⑨ ⑩

①	Motor Type	BLMR: BLV Series R Type Motor
②	Frame Size	2: 60 mm
		4: 80 mm
		5: 90 mm
		6: 104 mm (110 mm for gearhead)
③	Output Power	60: 60 W 100: 100 W 200: 200 W 400: 400 W
④	Identification Number	S
⑤	Motor Connection Method	H: Connector Type
⑥	Power Supply Voltage	K: DC Input
⑦		M: Type with Electromagnetic Brake
⑧	Gear Ratio and Shaft Type	Number: Gearhead Gear Ratio
		A: Round Shaft Type
⑨	Gearhead Type	Blank: Parallel Shaft Gearhead
		FR: Hollow Shaft Flat Gearhead
		CS: CS Geared Motor
⑩	Cable Output Direction	F: Cable output in the side of the output shaft
		B: Cable output in the opposite side of the output shaft

Driver

BLVD - K R D

① ② ③ ④

①	Driver Type	BLVD: BLV Series Driver
②	Power Supply Voltage	K: DC Input
③	Type	R Type
④	Identification Number	D

Connection Cables / Flexible Connection Cables

CCM 010 B1AA F

① ② ③ ④

①	Cable Type	CCM: Connection Cable
②	Length	003: 0.3 m 010: 1 m 020: 2 m
		030: 3 m
③	Identification Number	B1AA, B1AB
④		F: Connection Cable R: Flexible Connection Cable

Product Line

Please purchase the motor, driver, connection cable, and power supply cable separately.

● Motor

◇ Parallel Shaft Gearhead



Output Power	Product Name	Gear Ratio
60 W	BLMR460SHK -□	5, 10, 15, 20
		30, 50, 100
100 W	BLMR5100K -□-■	10, 15, 20
		30, 50, 100
200 W	BLMR6200SK -□-■	10, 15, 20
		30, 50 100
400 W	BLMR6400SK -□-■	10, 15, 20
		30, 50

● Electromagnetic Brake Motor

◇ Parallel Shaft Gearhead



Output Power	Product Name	Gear Ratio
100 W	BLMR5100KM -□-■	10, 15, 20
		30, 50, 100
200 W	BLMR6200SKM -□-■	10, 15, 20
		30, 50 100
400 W	BLMR6400SKM -□-■	10, 15, 20
		30, 50

◇ Hollow Shaft Flat Gearhead



Output Power	Product Name	Gear Ratio
60 W	BLMR460SHK -□ FR	5, 10, 15, 20
		30, 50, 100
		200
100 W	BLMR5100K -□ FR -■	10, 15, 20
		30, 50, 100
		200
200 W	BLMR6200SK -□ FR -■	10, 15, 20
		30, 50, 100
400 W	BLMR6400SK -□ FR -■	10, 15, 20
		30, 50, 100

◇ Hollow Shaft Flat Gearhead



Output Power	Product Name	Gear Ratio
100 W	BLMR5100KM -□ FR -■	10, 15, 20
		30, 50, 100
		200
200 W	BLMR6200SKM -□ FR -■	10, 15, 20
		30, 50, 100
400 W	BLMR6400SKM -□ FR -■	10, 15, 20
		30, 50, 100

◇ CS Geared Motor*



Output Power	Product Name	Gear Ratio
60 W	BLMR260HK -□ CS	5, 10, 15, 20

*A geared motor in which the motor and gearhead are integrated. The combination of motors and gearheads can not be changed.

◇ Round Shaft Type



Output Power	Product Name
60 W	BLMR260HK-A
100 W	BLMR5100K-A -■
200 W	BLMR5200K-A -■
400 W	BLMR5400K-A -■

◇ Round Shaft Type



Output Power	Product Name
100 W	BLMR5100KM-A -■
200 W	BLMR5200KM-A -■
400 W	BLMR5400KM-A -■

● Driver



Output Power	Product Name
60 W 100 W 200 W 400 W	BLVD-KRD

● A number indicating the gear ratio is specified where the box □ is located in the product name.

The letter **F** or **B** indicating the cable output direction is specified where the box ■ is located in the product name.

● Connection Cable



◇ For 60 W

Length	Product Name
0.3 m	CCM003B1ABF
1 m	CCM010B1ABF
2 m	CCM020B1ABF
3 m	CCM030B1ABF

● Flexible Connection Cable



◇ For 60 W

Length	Product Name
1 m	CCM010B1ABR
2 m	CCM020B1ABR
3 m	CCM030B1ABR

◇ For 100 W, 200 W, and 400 W



Length	Product Name
1 m	CCM010B1AAF
2 m	CCM020B1AAF
3 m	CCM030B1AAF

● Power Supply Cable



Length	Product Name
0.6 m	LC03D06A

■ Included Items

Type	Parallel Key	Safety Cover	Installation Screws
Parallel Shaft Gearhead	1	—	1 set
Hollow Shaft Flat Gearhead	1	1 set	1 set
CS Geared Motor	1	—	1 set
Round Shaft	—	—	—
Driver	—	—	—

Direct Connection (60 W)

The motor and driver can be connected with one cable.
Please purchase a connection cable.

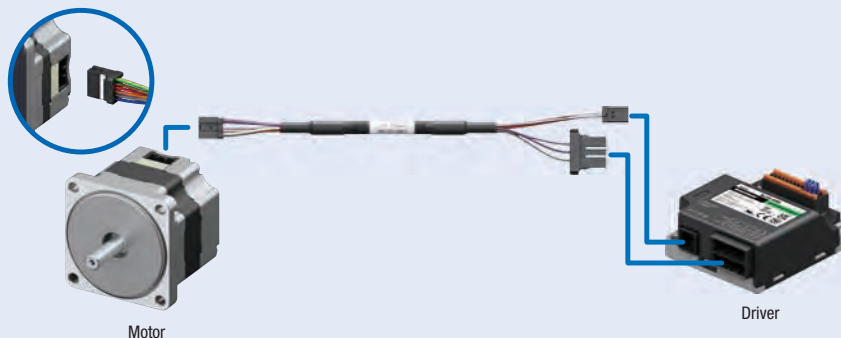

List of Combinations

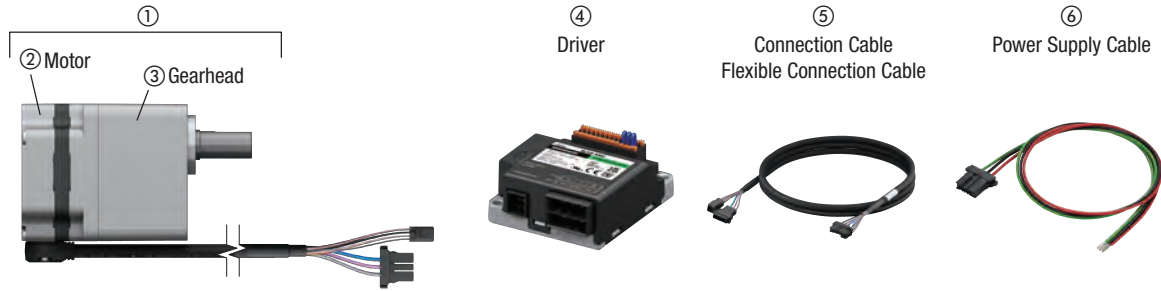

Motor

Output Power	Type	Brushless Motors			Driver	Connection cable Flexible Connection Cable	Power Supply Cable
		Product Name	Components		Product Name	Product Name	Product Name
		①	②	③	④	⑤	⑥
60 W	Parallel Shaft Gearhead	BLMR460SHK-□	BLMR460SHK-GFV	GFV4G□	BLVD-KRD	CCM003B1ABF CCM010B1AB◇ CCM020B1AB◇ CCM030B1AB◇	LC03D06A
	Hollow Shaft Flat Gearhead	BLMR460SHK-□FR		GFS4G□FR			
	CS Geared Motor	BLMR260HK-□CS	—	—			
	Round Shaft Type	BLMR260HK-A	—	—			
100 W	Parallel Shaft Gearhead	BLMR5100K-□-■	BLMR5100K-GFV-■	GFV5G□			
	Hollow Shaft Flat Gearhead	BLMR5100K-□FR-■		GFS5G□FR			
	Round Shaft Type	BLMR5100K-A-■	—	—			
200 W	Parallel Shaft Gearhead	BLMR6200SK-□-■	BLMR6200SK-GFV-■	GFV6G□			
	Hollow Shaft Flat Gearhead	BLMR6200SK-□FR-■		GFS6G□FR			
	Round Shaft Type	BLMR5200K-A-■	—	—			
400 W	Parallel Shaft Gearhead	BLMR6400SK-□-■	BLMR6400SK-GFV-■	GFV6G□			
	Hollow Shaft Flat Gearhead	BLMR6400SK-□FR-■		GFS6G□FR			
	Round Shaft Type	BLMR5400K-A-■	—	—			

Electromagnetic Brake Motor

Output Power	Type	Brushless Motors			Driver	Connection cable	Power Supply Cable
		Product Name	Components		Product Name	Product Name	Product Name
		①	②	③	④	⑤	⑥
100 W	Parallel Shaft Gearhead	BLMR5100KM-□-■	BLMR5100KM-GFV-■	GFV5G□	BLVD-KRD	CCM010B1AAF CCM020B1AAF CCM030B1AAF	LC03D06A
	Hollow Shaft Flat Gearhead	BLMR5100KM-□FR-■		GFS5G□FR			
	Round Shaft Type	BLMR5100KM-A-■	—	—			
200 W	Parallel Shaft Gearhead	BLMR6200SKM-□-■	BLMR6200SKM-GFV-■	GFV6G□			
	Hollow Shaft Flat Gearhead	BLMR6200SKM-□FR-■		GFS6G□FR			
	Round Shaft Type	BLMR5200KM-A-■	—	—			
400 W	Parallel Shaft Gearhead	BLMR6400SKM-□-■	BLMR6400SKM-GFV-■	GFV6G□			
	Hollow Shaft Flat Gearhead	BLMR6400SKM-□FR-■		GFS6G□FR			
	Round Shaft Type	BLMR5400KM-A-■	—	—			

● A number indicating the gear ratio is specified where the box □ is located in the product name.

The letter **F** or **B** indicating the cable output direction is specified where the box ■ is located in the product name.

The letter **F** (connection cable) or **R** (flexible connection cable) is specified where the symbol ◇ is located in the product name.

Parallel Shaft Gearheads

60 W, 100 W, 200 W, 400 W



Specifications



Product Name	Motor	With Electromagnetic Brake	BLMR460SHK-□	BLMR5100K-□-■	BLMR6200SK-□-■	BLMR6400SK-□-■
	Driver		—	BLMR5100KM-□-■	BLMR6200SKM-□-■	BLMR6400SKM-□-■
			BLVD-KRD			
Rated Output Power	W		60	100	200	400
Power Supply	Rated Voltage	V	24–48 VDC			48 VDC
	Operating Voltage	V	15–55 VDC			30–55 VDC
Input	Rated Input Current	A	1.7 (48 V) - 3.3 (24 V)	2.6 (48 V) - 5.1 (24 V)	5.3 (48 V) - 10.5 (24 V)	10.4
	Max. Input Current	A	5.5	10	18	16
Rated Speed	r/min		3000			
Speed Control Range*1			1 - 4000 r/min (Speed ratio 1:4000)			
Speed Regulation	Load		±0.01% or less: Conditions 0 - rated torque, rated speed, rated voltage, normal ambient temperature			
	Voltage		±0.01% or less: Conditions Rated voltage, rated speed, no load, normal ambient temperature			
	Temperature		±0.01% or less: Conditions Operating ambient temperature 0 - +40°C, rated speed, no load, rated voltage			
Resolution*1			0.01° (1 rotation: 36000 pulses)			
Electromagnetic Brake	Type		—			
	Static Friction Torque	N·m	—	0.319	0.637	1.27
Time Rating			Continuous	Continuous	Continuous	30 minutes*2

*1 Factory setting.

*2 Check the Speed – Torque Characteristics for details. → Page 24

Gear Ratio		5	10	15	20	30	50	100*1	
Rotation Direction	60/100 W	Same direction as motor				Opposite direction from motor			
	200/400 W	Same direction as motor				Opposite direction from motor		Same direction as motor	
Output Shaft Speed [r/min]*2	1 r/min	0.2	0.1	0.067	0.05	0.033	0.02	0.01	
	3000 r/min	600	300	200	150	100	60	30	
	4000 r/min	800	400	267	200	133	80	40	
Permissible Torque [Nm]	60 W	At 1 - 3000 r/min	0.86	1.7	2.6	3.4	4.9	8.2	16
		At 4000 r/min	0.43	0.86	1.3	1.7	2.5	4.1	8.3
	100 W	At 1 - 3000 r/min	-	2.9	4.3	5.7	8.2	13.7	27.4
		At 4000 r/min	-	2.2	3.2	4.3	6.2	10.3	20.6
	200 W	At 1 - 3000 r/min	-	5.7	8.6	11.5	16.4	27.4	51.6
		At 4000 r/min	-	4.1	6.1	8.1	11.6	19.4	36.5
400 W	At 1 - 3000 r/min	-	11.4	17.1	22.9	32.8	55	-	
	At 4000 r/min	-	8.6	12.9	17.2	24.6	41.1	-	
Max. Instantaneous Torque [Nm]	60 W	1.7	3.4	5.2	6.9	9.9	16.4	20	
	100 W	-	5.7	8.6	11.5	16.5	27.4	40	
	200 W	-	11.5	17.2	22.9	32.9	55	100	
	400 W	-	22.9	34.3	45	66	85	-	
Permissible Inertia J [$\times 10^{-4}$ kgm ²]	When deceleration time is set*3	60 W	245	980	2205	3920	8820	24500	98000
		100 W	-	2300	5175	9200	20700	57500	230000
		200 W	-	3400	7650	13600	30600	85000	340000
		400 W	-	4500	10125	18000	40500	112500	-
	When immediately stopped*4	60 W	5.5	22	49.5	88	198	550	
		100 W	-	100	225	400	900	2500	
		200 W	-	200	450	800	1800	5000	
		400 W	-	-	-	-	-	-	
Permissible Radial Load [N]	From the end of the output shaft 10 mm	60 W	At 1 - 3000 r/min	200	300		450		
			At 4000 r/min	180	270		420		
		100 W	At 1 - 3000 r/min	-	400		500		
			At 4000 r/min	-	370		450		
	200 W	At 1 - 3000 r/min	-	550		1000	1400		
		At 4000 r/min	-	500		900	1200		
	From the end of the output shaft 20 mm	60 W	At 1 - 3000 r/min	250	350		550		
			At 4000 r/min	220	330		500		
		100 W	At 1 - 3000 r/min	-	500		650		
			At 4000 r/min	-	430		550		
200 W		At 1 - 3000 r/min	-	800		1250	1700		
		At 4000 r/min	-	700		1100	1400		
Permissible Axial Load [N]	60 W	100							
	100 W	-	150						
	200 W	-	200		300		400		
	400 W	-	200		300		400		

*1 The gear ratio of **100** is compatible with the 60 W type, 100 W type, and 200 W type.

*2 The output shaft speed is the speed divided by the gear ratio.

*3 The maximum permissible inertia when the deceleration time is set to 0.1 seconds or higher. Please set the acceleration time so that the torque needed for acceleration/deceleration does not exceed the maximum instantaneous torque.

*4 Also applicable when the deceleration time is set to below 0.1 seconds.

● The values correspond to each specification and characteristics of a stand-alone motor.

A number indicating the gear ratio is specified where the box □ is located in the product name.

The letter **F** or **B** indicating the cable output direction is specified where the box ■ is located in the product name.

◇ Load Position

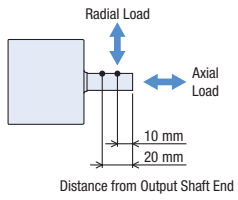

■ Speed – Torque Characteristics

→ Page 24

■ Dimensions

Motor → Pages 26 and 27

Electromagnetic Brake Motor → Pages 33 and 34

Driver → Page 40

Hollow Shaft Flat Gearhead

60 W, 100 W, 200 W, 400 W



Specifications



Product Name	Motor	With Electromagnetic Brake	BLMR460SHK-□FR	BLMR5100K-□FR-■	BLMR6200SK-□FR-■	BLMR6400SK-□FR-■
			BLMR5100KM-□FR-■	BLMR6200SKM-□FR-■	BLMR6400SKM-□FR-■	
Driver			BLVD-KRD			
Rated Output Power	W		60	100	200	400
Power Supply Input	Rated Voltage	V	24-48 VDC			48 VDC
	Operating Voltage	V	15-55 VDC			30-55 VDC
	Rated Input Current	A	1.7 (48 V) - 3.3 (24 V)	2.6 (48 V) - 5.1 (24 V)	5.3 (48 V) - 10.5 (24 V)	10.4
	Max. Input Current	A	5.5	10	18	16
Rated Speed	r/min		3000			
Speed Control Range*1			1 - 4000 r/min (Speed ratio 1:4000)			
Speed Regulation	Load		±0.01% or less: Conditions 0 - rated torque, rated speed, rated voltage, normal ambient temperature			
	Voltage		±0.01% or less: Conditions Rated voltage, rated speed, no load, normal ambient temperature			
	Temperature		±0.01% or less: Conditions Operating ambient temperature 0 - +40°C, rated speed, no load, rated voltage			
Resolution*1			0.01° (1 rotation: 36000 pulses)			
Electromagnetic Brake	Type		Power off activated type, automatically controlled by the driver			
	Static Friction Torque	Nm	-	0.319	0.637	1.27
Time Rating			Continuous	Continuous	Continuous	30 minutes*2

*1 Factory setting.

*2 Check the Speed - Torque Characteristics for details. → Page 24

Gear Ratio										
	5	10	15	20	30	50	100	200		
Output Shaft Speed [r/min]*1	1 r/min	0.2	0.1	0.067	0.05	0.033	0.02	0.01	0.005	
	3000 r/min	600	300	200	150	100	60	30	15	
	4000 r/min	800	400	267	200	133	80	40	20	
Permissible Torque [Nm]	60 W	At 1 - 3000 r/min	0.81	1.6	2.4	3.2	4.9	8.1	16.2	32.5
		At 4000 r/min	0.41	0.82	1.2	1.6	2.4	4.1	8.2	16.3
	100 W	At 1 - 3000 r/min	-	2.7	4.1	5.4	8.1	13.6	27.1	54
		At 4000 r/min	-	2.0	3.0	4.1	6.1	10.2	20.3	40.6
	200 W	At 1 - 3000 r/min	-	5.4	8.1	10.8	16.2	27	54	-
		At 4000 r/min	-	3.8	5.7	7.7	11.5	19.1	38.3	-
	400 W	At 1 - 3000 r/min	-	10.8	16.2	21.6	32.4	54	108	-
		At 4000 r/min	-	8.1	12.2	16.2	24.4	40.6	81	-
Max. Instantaneous Torque [Nm]	60 W	1.6	3.2	4.9	6.5	9.7	16.2	32.5	51	
	100 W	-	5.4	8.1	10.8	16.3	27.1	54	85	
	200 W	-	10.8	16.2	21.7	32.5	54	108	-	
	400 W	-	21.6	32.4	43.2	65	108	167	-	
Permissible Inertia J [$\times 10^{-4}$ kgm ²]	When deceleration time is set*2	60 W	245	980	2205	3920	8820	24500	98000	392000
		100 W	-	2300	5175	9200	20700	57500	230000	920000
		200 W	-	3400	7650	13600	30600	85000	340000	-
		400 W	-	4500	10125	18000	40500	112500	450000	-
	When immediately stopped*3	60 W	5.5	22	49.5	88	198	550		
		100 W	-	100	225	400	900	2500		
		200 W	-	200	450	800	1800	5000		
		400 W	-	200	450	800	1800	5000		
Permissible Radial Load [N]*4	From installation surface 10 mm	60 W	At 1 - 3000 r/min	800		1200				
		At 4000 r/min	730		1100					
		100 W	At 1 - 3000 r/min	-	900	1300		1500		
		At 4000 r/min	-	820	1200		1400			
	From installation surface 20 mm	200 W	At 1 - 3000 r/min	-	1230	1680		2040		
		At 4000 r/min	-	1130	1550		1900			
		400 W	At 1 - 3000 r/min	-	660	1000		-		
		At 4000 r/min	-	600	910		-			
Permissible Axial Load [N]	60 W	400								
	100 W	-	500							
	200 W	-	800							
	400 W	-	800							

*1 The output shaft speed is the speed divided by the gear ratio.

*2 The maximum permissible inertia when the deceleration time is set to 0.1 seconds or higher. Please set the acceleration time so that the torque needed for acceleration/deceleration does not exceed the maximum instantaneous torque.

*3 Also applicable when the deceleration time is set to below 0.1 seconds.

*4 The radial load at each distance can also be calculated with a formula. → Page 42

● The values correspond to each specification and characteristics of a stand-alone motor.

A number indicating the gear ratio is specified where the box □ is located in the product name.

The letter **F** or **B** indicating the cable output direction is specified where the box ■ is located in the product name.

◇ Rotation Direction

•Viewed from front face

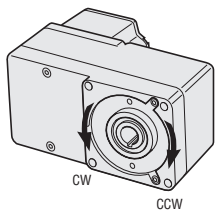

•Viewed from back face

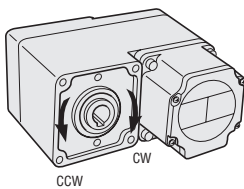

◇ Load Position

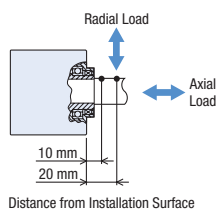

■ Speed – Torque Characteristics

→ Page 24

■ Dimensions

Motor → Pages 28~30

Electromagnetic Brake Motor → Pages 35~37

Driver → Page 40

CS Geared Motor 60 w



Specifications



Product Name	Motor Driver	BLMR260HK-□CS BLVD-KRD	
Rated Output Power	W	60	
Power Supply Input	Rated Voltage	V	24-48 VDC
	Operating Voltage	V	15-55 VDC
	Rated Input Current	A	1.7 (48 V) - 3.3 (24 V)
	Max. Input Current	A	5.5
Rated Speed	r/min	3000	
Speed Control Range*		1 - 4000 r/min (Speed ratio 1:4000)	
Speed Regulation	Load	±0.01% or less: Conditions 0 - rated torque, rated speed, rated voltage, normal ambient temperature	
	Voltage	±0.01% or less: Conditions Rated voltage, rated speed, no load, normal ambient temperature	
	Temperature	±0.01% or less: Conditions Operating ambient temperature 0 - +40°C, rated speed, no load, rated voltage	
Resolution*		0.01° (1 rotation: 36000 pulses)	
Time Rating		Continuous	

*Factory setting.

Gear Ratio		5	10	15	20
Rotation Direction		Same direction as motor			
Output Shaft Speed [r/min]*1	1 r/min	0.2	0.1	0.067	0.05
	3000 r/min	600	300	200	150
	4000 r/min	800	400	267	200
Permissible Torque [Nm]	At 1 - 3000 r/min	0.86	1.7	2.6	3.4
	At 4000 r/min	0.43	0.86	1.3	1.7
Max. Instantaneous Torque [Nm]		1.7	3.4	5.2	6.9
Permissible Inertia J [$\times 10^{-4}$ kgm ²]	When deceleration time is set*2	245	980	2205	3920
	When immediately stopped*3	3.1	12.4	28	49.6
Permissible Radial Load [N]	From the end of the output shaft 10 mm	At 1 - 3000 r/min	200		
		At 4000 r/min	180		
	From the end of the output shaft 20 mm	At 1 - 3000 r/min	260		
		At 4000 r/min	230		
Permissible Axial Load [N]		70			

*1 The output shaft speed is the speed divided by the gear ratio.

*2 The maximum permissible inertia when the deceleration time is set to 0.1 seconds or higher. Please set the acceleration time so that the torque needed for acceleration/deceleration does not exceed the maximum instantaneous torque.

*3 Also applicable when the deceleration time is set to below 0.1 seconds.

◇ Load Position

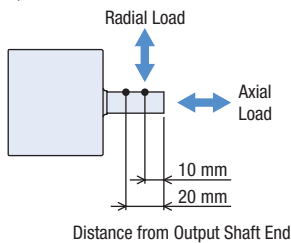

Speed - Torque Characteristics

→ Page 24

Dimensions

Motor → Page 31

Driver → Page 40

● The values correspond to each specification and characteristics of a stand-alone motor.

A number indicating the gear ratio is specified where the box □ is located in the product name.

Round Shaft 60 W, 100 W, 200 W, 400 W



Specifications



Product Name	Motor	With Electromagnetic Brake	BLMR260HK-A	BLMR5100K-A-□	BLMR5200K-A-□	BLMR5400K-A-□
	Driver			BLMR5100KM-A-□	BLMR5200KM-A-□	BLMR5400KM-A-□
Rated Output Power	W		60	100	200	400
Power Supply Input	Rated Voltage	V	24–48 VDC			48 VDC
	Operating Voltage	V	15–55 VDC			30–55 VDC
	Rated Input Current	A	1.7 (48 V) - 3.3 (24 V)	2.6 (48 V) - 5.1 (24 V)	5.3 (48 V) - 10.5 (24 V)	10.4
	Max. Input Current	A	5.5	10	18	16
Rated Speed	r/min		3000			
Speed Control Range*1			1 - 4000 r/min (Speed ratio 1:4000)			
Rated Torque	Nm		0.191	0.319	0.637	1.27
Maximum Instantaneous Torque	Nm		0.382 (200%)	0.704 (220%)	1.34 (210%)	2.54 (200%)
Rotor Inertia J	$\times 10^{-4} \text{kgm}^2$		0.098	0.252 (0.267)*2	0.499 (0.514)*2	0.737 (0.751)*2
Permissible Inertia J	$\times 10^{-4} \text{kgm}^2$		9.8	23	34	45
Permissible Radial Load	From the end of the output shaft 10 mm	N	70	150		
	From the end of the output shaft 20 mm	N	100	170		
Permissible Axial Load	N		15	25		
Speed Regulation	Load		$\pm 0.01\%$ or less: Conditions 0 - rated torque, rated speed, rated voltage, normal ambient temperature			
	Voltage		$\pm 0.01\%$ or less: Conditions Rated voltage, rated speed, no load, normal ambient temperature			
	Temperature		$\pm 0.01\%$ or less: Conditions Operating ambient temperature 0 - +40°C, rated speed, no load, rated voltage			
Resolution*1			0.01° (1 rotation: 36000 pulses)			
Electromagnetic Brake	Type		–	Power off activated type, automatically controlled by the driver		
	Static Friction Torque	Nm	–	0.319	0.637	1.27
Time Rating			Continuous	Continuous	Continuous	30 minutes*3

*1 Factory setting.

*2 The brackets () indicate the specifications for the electromagnetic brake motor.

*3 Check the Speed – Torque Characteristics for details. → Page 24

◇ Load Position

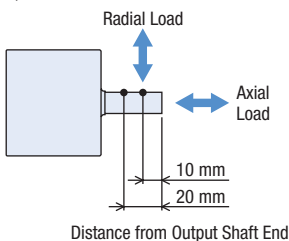

● The letter **F** or **B** indicating the cable output direction is specified where the box □ is located in the product name.

Speed – Torque Characteristics

Continuous Duty Region: Continuous operation is possible in this region.

Limited Duty Region: This region is used primarily when accelerating.

60 W

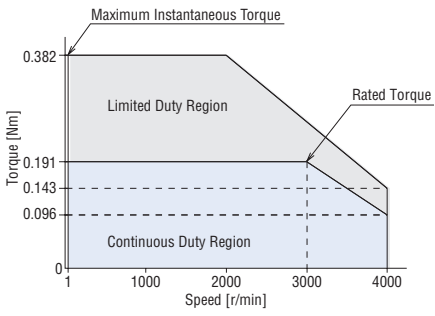

100 W

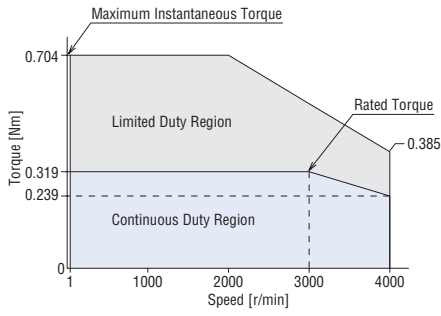

200 W

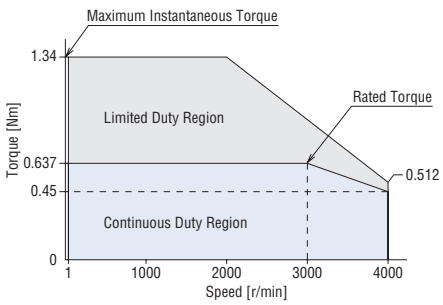

400 W

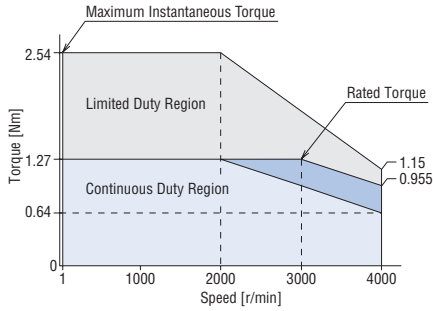

● The values correspond to each specification and characteristics of a stand-alone motor. The speed - torque characteristics show the values when rated voltage is applied.

● is the region with a time rating of 30 minutes. Operation for more than 30 minutes may be possible depending on the ambient temperature and heat radiation conditions.

Dimensions

Motor → Pages 31 and 32

Electromagnetic Brake Motor → Pages 38 and 39

Driver → Page 40

Common Specifications

Item	Specifications
Input Signals	4 points, Photocoupler Input Mode
Output Signals	2 points, Photocoupler and Open-Collector Output
Main Operation Functions	Continuous Operation, Positioning Operation, JOG Operation, Return-to-Home Operation
Operating Data Setting Number	256 Points
Setting Tool	Support Software MEXE02
Maximum Extension Length	Motor and Driver Distance: 3.5 m* (when a connection cable sold separately is used)

*3.0 m for the 60 W type.

Communication Specifications

Power Supply for Communication

Power Supply Current Capacitance	Input Power Supply Voltage
0.2 A min.	24–48 VDC

RS-485 Communication Specifications

Electrical Characteristics	Complies with EIA-485. The maximum total extension length of the communication cable is 10 m when using twisted-pair wires. *
Communication Mode	Half duplex Start-stop synchronization (data: 8 bits, stop bit: 1 bit or 2 bits, parity: none, even, or odd)
Baud Rate	Select from 9,600 bps, 19,200 bps, 38,400 bps, 57,600 bps, 115,200 bps, and 230,400 bps (initial value)
Protocol	Modbus RTU Mode
Connection Type	Up to 31 units can be connected to a single host system.

*If noise generated by the motor cable or power supply cable causes a problem with the specific wiring or layout, shield the cable or use ferrite cores.

CANopen Communication Specifications

Electrical Characteristics	ISO 11898-compliant Use a CAN-BUS cable.
Communication Protocol	CANopen
Communication Profile	CiA DS301 Version 4.2.0-compliant
Device Profile	CiA DSP402 Version 4.0.0-compliant
Node ID	1 - 127
Bit Rate	Select from 1 Mbps, 800 kbps, 500 kbps (initial value), 250 kbps, 125 kbps, 50 kbps, 20 kbps, and 10 kbps
Max. Bus Length	25 m (Max. bus length at 1 Mbps)
Communication Objects	NMT (Network Management) SDO (Service Data Object: 1 SDO server) PDO (Process Data Object: 4 Receive-PDO, 4 Transmit-PDO) EMCY (Emergency Object) SYNC (Synchronization Object)
Operation Modes	Profile velocity mode (pv) Profile position mode (pp) Homing mode (hm)

General Specifications

Item	Motor	Driver
Insulation Resistance	100 MΩ or more when a 500 VDC megger is applied between the windings and the case after continuous operation*1 under normal ambient temperature and humidity.	100 MΩ or more when 500 VDC megger is applied between the heat sink and the main power supply input terminal after continuous operation under normal ambient temperature and humidity.
Dielectric Strength	Sufficient to withstand 0.5 kVAC at 50 Hz applied between the windings and the case for 1 minute after continuous operation*1 under normal ambient temperature and humidity.	Sufficient to withstand 0.5 kVAC at 50 Hz applied between the heat sink and the main power supply input terminal for 1 minute after continuous operation under normal ambient temperature and humidity.
Temperature Rise	The temperature rise of the windings is 60°C max. and that of the case surface is 50°C max.*2, measured by the thermocouple method after rated continuous operation*1 under normal ambient temperature and humidity.	The temperature rise of the heat sink is 50°C max., measured by the thermocouple method after rated continuous operation under normal ambient temperature and humidity.
Operating Environment	Ambient Temperature	0 - +40°C (Non-freezing)
	Ambient Humidity	85% max. (Non-condensing)
	Altitude	Up to 1000 m above sea level
	Atmosphere	No corrosive gases or dust. Should not be exposed to oil. Cannot be used in a radioactive area, magnetic field, vacuum, or other special environments.
Vibration	Not subject to continuous vibration or excessive shock In conformance with JIS C 60068-2-6, "Sine-wave vibration test method" Frequency Range: 10 - 55 Hz, Half Amplitude: 0.15 mm Sweep Direction: 3 directions (X, Y, Z) Number of Sweeps: 20 times	
Storage Condition*4	Ambient Temperature	-20 - +70°C (Non-freezing)
	Ambient Humidity	85% max. (Non-condensing)
	Altitude	Up to 3000 m above sea level
	Atmosphere	No corrosive gases or dust. Should not be exposed to water or oil. Cannot be used in a radioactive area, magnetic field, vacuum, or other special environments.
Thermal Class	UL/CSA Standards: 105 (A), EN Standards: 120 (E)	—
Degree of Protection	IP40	IP20

*1 30 minutes rating for the 400 W type

*2 For the round shaft type, install on a heat sink (material: aluminum) of the following size so that the surface temperature of the motor case does not exceed 90°C.

60 W type: 135×135 mm, thickness 5 mm, 100 W type: 165×165 mm, thickness 5 mm, 200 W type: 200×200 mm, thickness 5 mm, 400 W type: 250×250 mm, thickness 6 mm

*3 Install the driver to a location that has the same heat radiation capability as an aluminum metal plate.

200×200 mm, thickness 2 mm

*4 The storage condition applies to short periods such as the period during transport.

Note

● Do not measure insulation resistance or perform a dielectric strength test while the motor and driver are connected.

Dimensions (Unit = mm)

- Check "Included" for the products that include the installation screws.

Included → Page 16/Installation Screw Dimensions → Page 41

- A number indicating the gear ratio is specified where the box □ is located in the product name.

The letter **F** (output in the side of the output shaft) or **B** (output in the opposite side of the output shaft) indicating the cable output direction is specified where the box ■ is located in the product name.

● Motor

◇ Parallel Shaft Gearhead • 60 W

Product Name	Motor Product Name	Gearhead Product Name	Gear Ratio	L	Mass [kg]
BLMR460SHK -□	BLMR460SHK -GFV	GFV4G □	5 - 20	41	1.2
			30 - 100	46	1.3

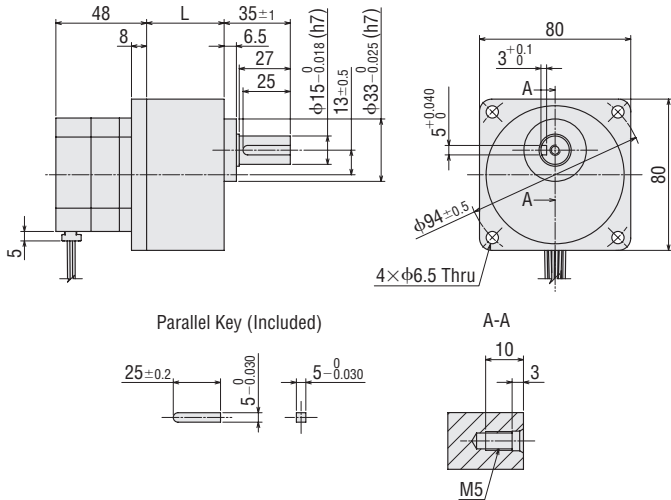

◇ Parallel Shaft Gearhead • 100 W

Product Name	Motor Product Name	Gearhead Product Name	Gear Ratio	L	Mass [kg]
BLMR5100K -□-■	BLMR5100K -GFV-■	GFV5G □	10 - 20	45	2.05
			30 - 100	58	2.4

- Cable output in the side of the output shaft

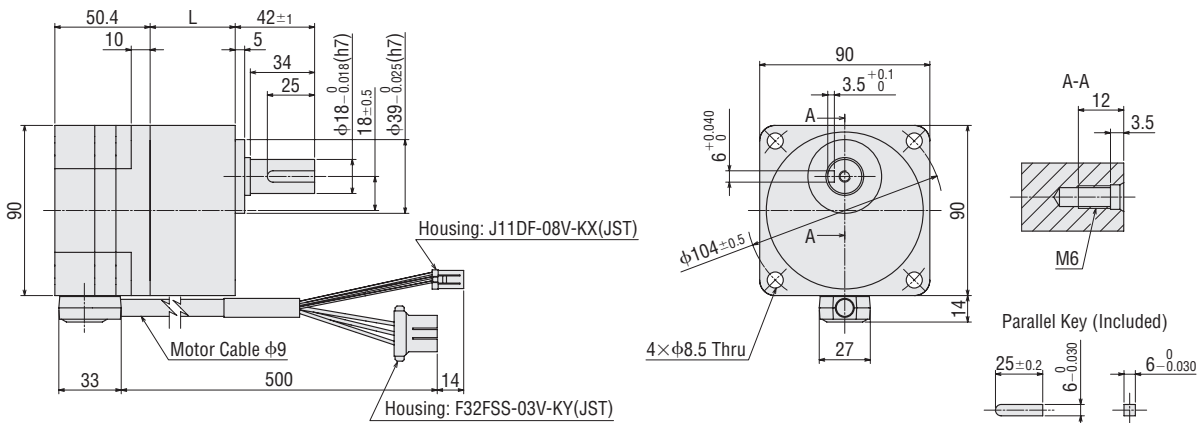

- Cable output in the opposite side of the output shaft

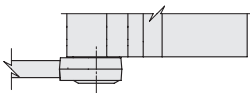

◇ Parallel Shaft Gearhead • 200 W

Product Name	Motor Product Name	Gearhead Product Name	Gear Ratio	L	Mass [kg]
BLMR6200SK -□-■	BLMR6200SK-GFV -■	GFV6G □	10 - 20	60	3.6
			30, 50	72	4.1
			100	86	4.7

● Cable output in the side of the output shaft

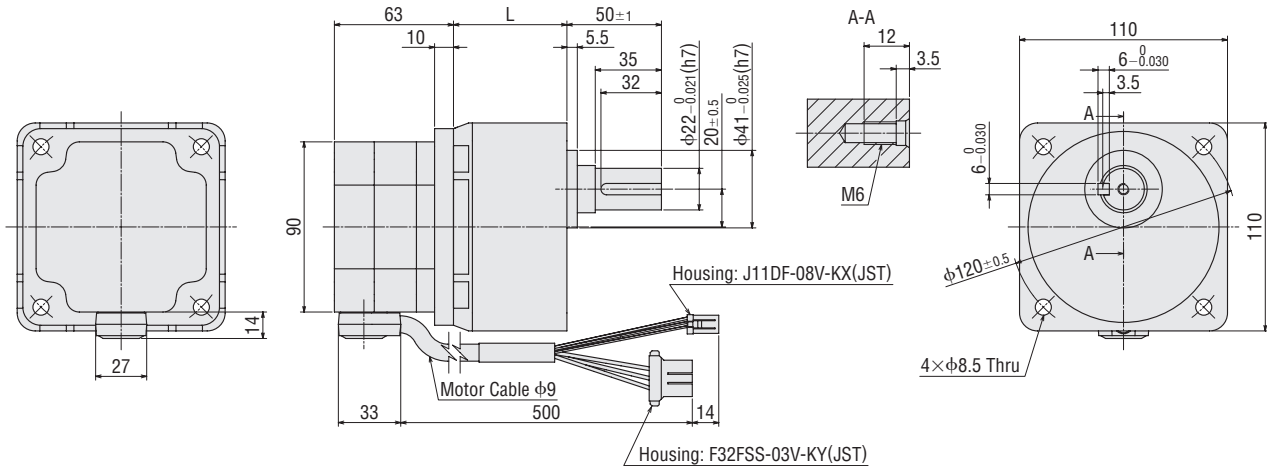

● Cable output in the opposite side of the output shaft

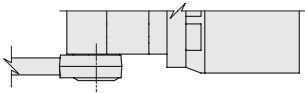

◇ Parallel Shaft Gearhead • 400 W

Product Name	Motor Product Name	Gearhead Product Name	Gear Ratio	L	Mass [kg]
BLMR6400SK -□-■	BLMR6400SK-GFV -■	GFV6G □	10 - 20	60	4.0
			30, 50	72	4.5

● Cable output in the side of the output shaft

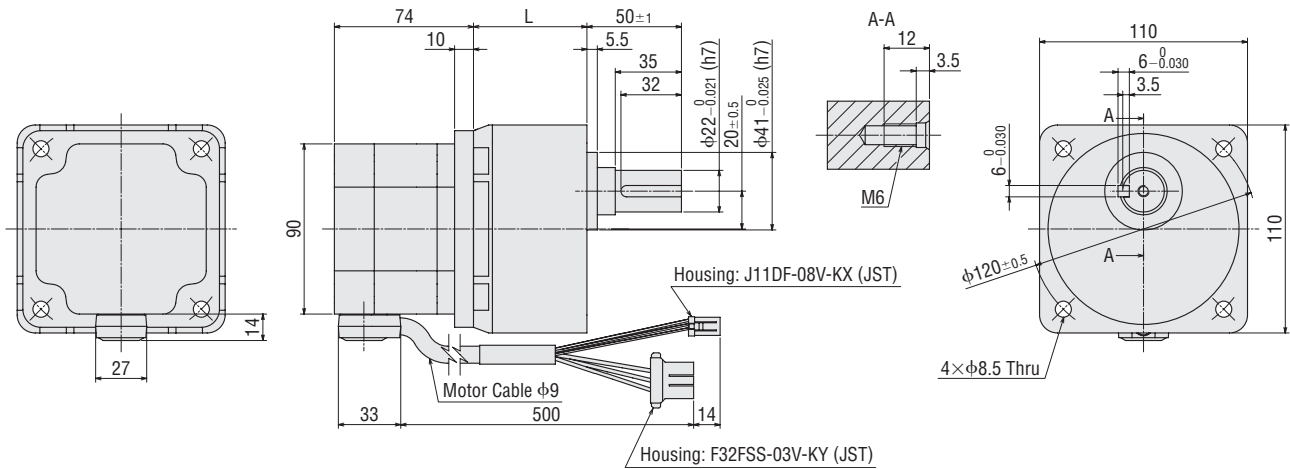

● Cable output in the opposite side of the output shaft

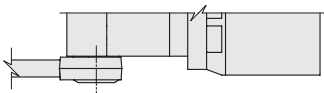

◇ Hollow Shaft Flat Gearhead • 60 W

Product Name	Motor Product Name	Gearhead Product Name	Mass [kg]
BLMR460SHK-□FR	BLMR460SHK-GFV	GFS4G□FR	2.1

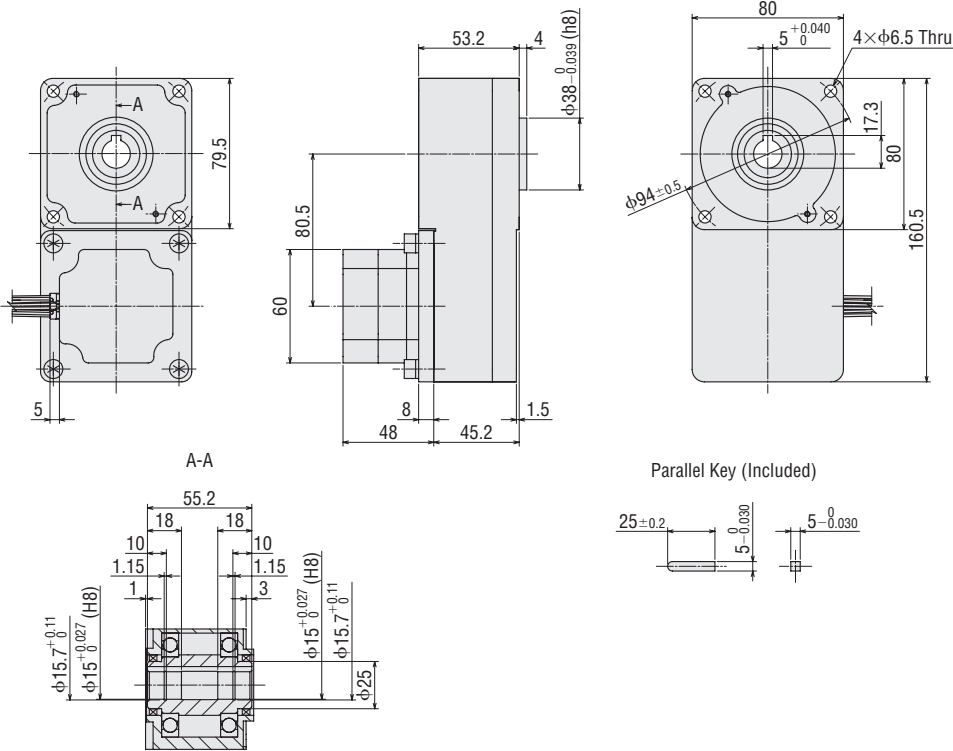

◇ Hollow Shaft Flat Gearhead • 100 W

Product Name	Motor Product Name	Gearhead Product Name	Mass [kg]
BLMR5100K-□FR-■	BLMR5100K-GFV-■	GFS5G□FR	3.3

● Cable output in the side of the output shaft

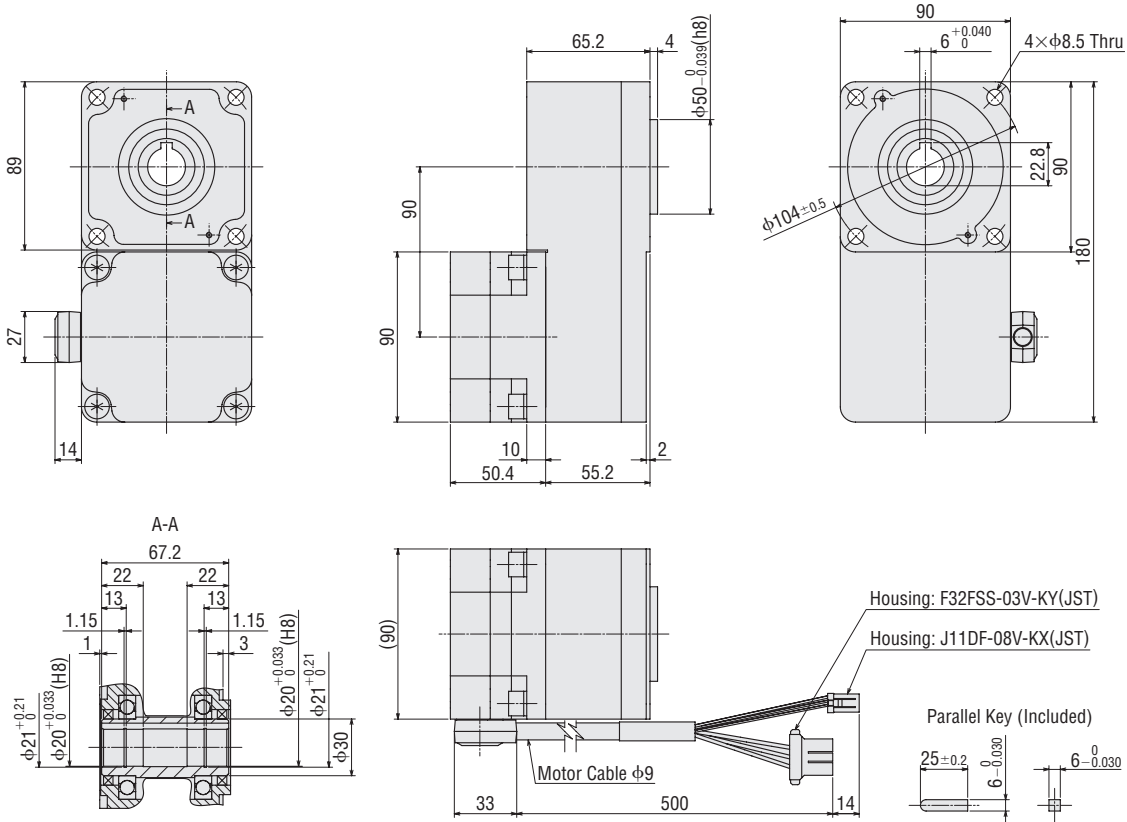

● Cable output in the opposite side of the output shaft

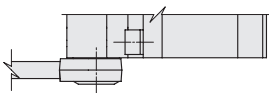

◇ Hollow Shaft Flat Gearhead • 200 W

Product Name	Motor Product Name	Gearhead Product Name	Mass [kg]
BLMR6200SK-□FR-■	BLMR6200SK-GFV-■	GFS6G□FR	6.5

• Cable output in the side of the output shaft

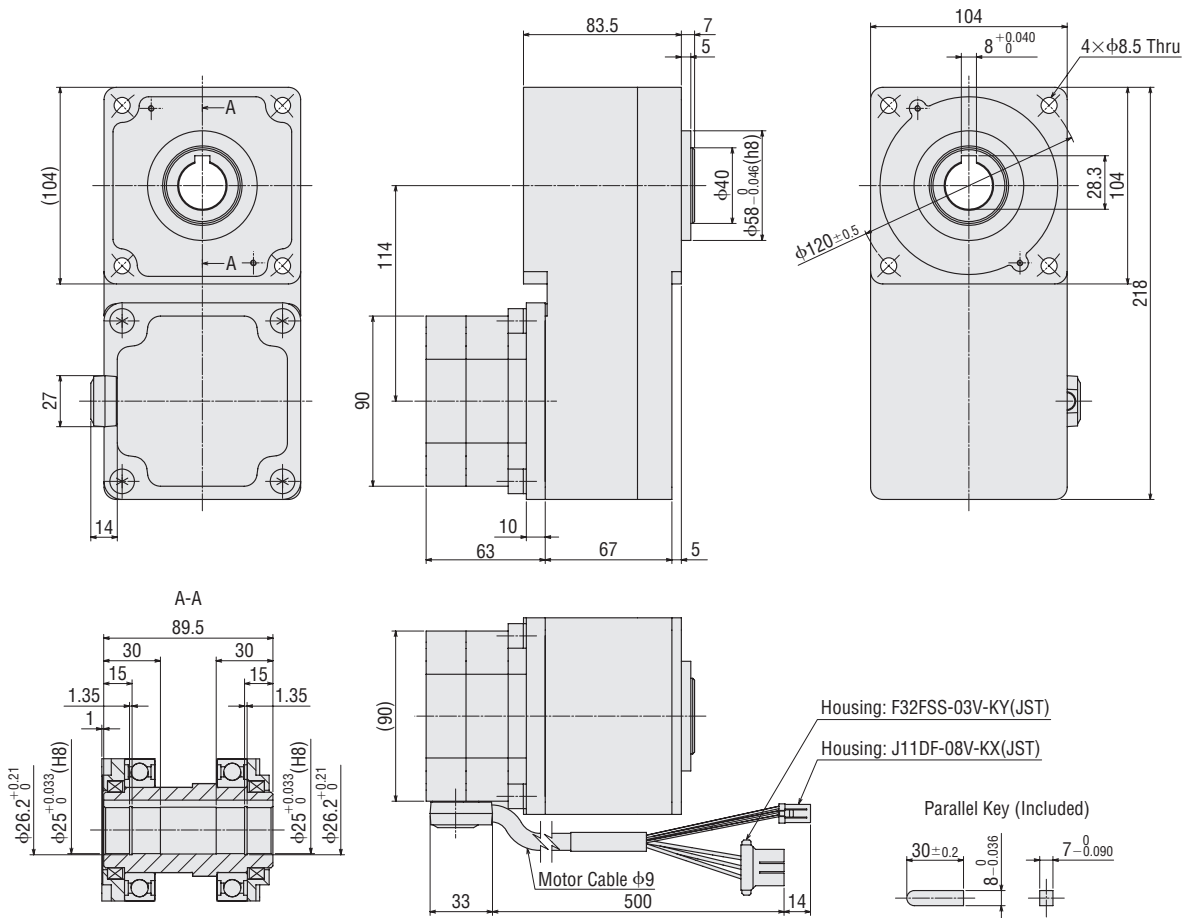

• Cable output in the opposite side of the output shaft

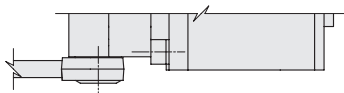

◇Hollow Shaft Flat Gearhead • 400 W

Product Name	Motor Product Name	Gearhead Product Name	Mass [kg]
BLMR6400SK-□FR-■	BLMR6400SK-GFV-■	GFS6G□FR	6.9

•Cable output in the side of the output shaft

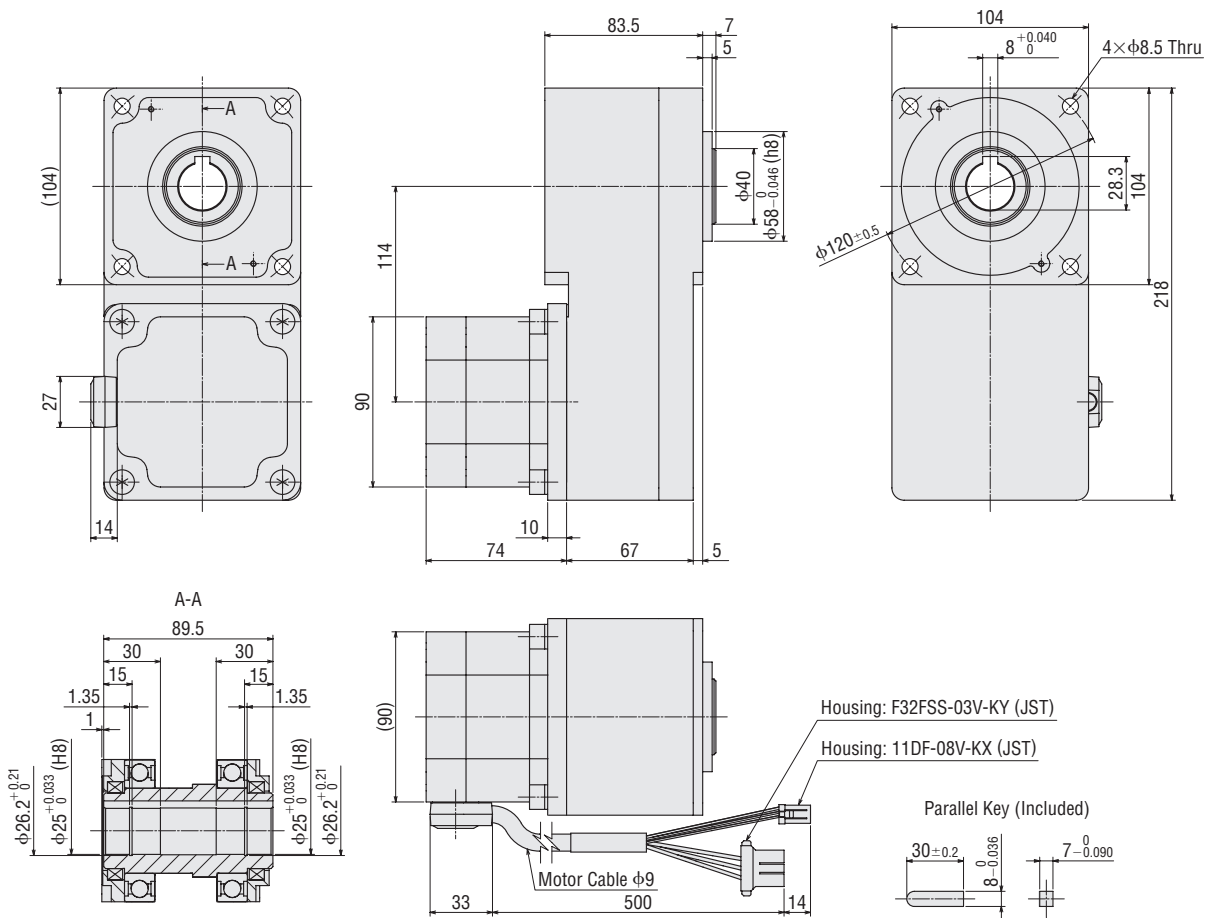

•Cable output in the opposite side of the output shaft

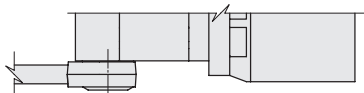

◇ **CS Geared Motor • 60 W**

BLMR260HK-□CS

Mass: 0.87 kg

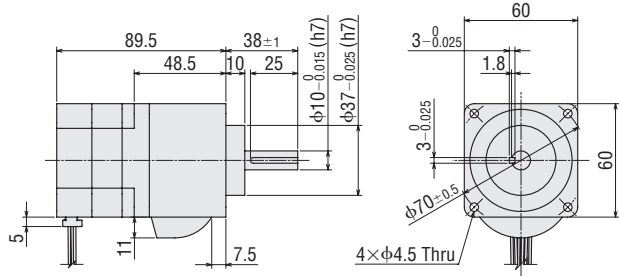

◇ **Round Shaft Type • 60 W**

BLMR260HK-A

Mass: 0.47 kg

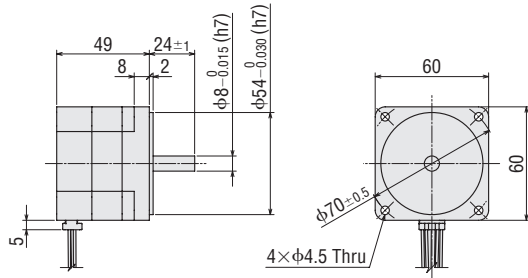

◇ **Round Shaft Type • 100 W**

BLMR5100K-A-■

Mass: 1.1 kg

- Cable output in the side of the output shaft

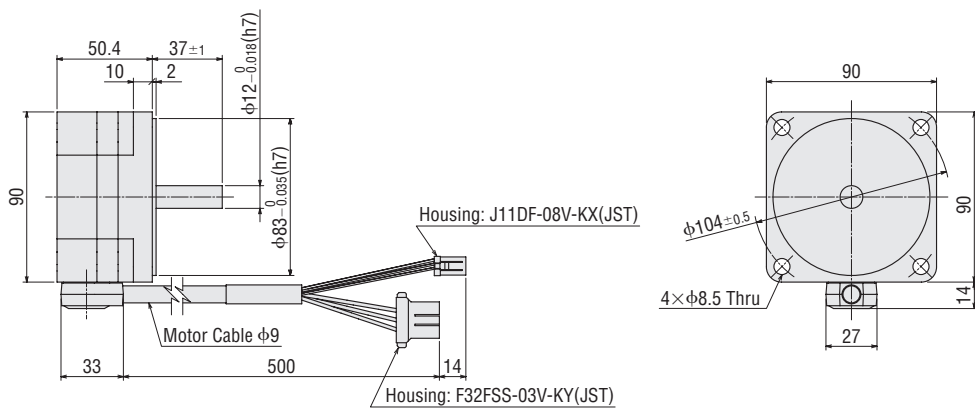

- Cable output in the opposite side of the output shaft

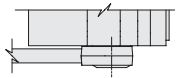

◇ Round Shaft Type • 200 W

BLMR5200K-A ■

Mass: 1.6 kg

- Cable output in the side of the output shaft

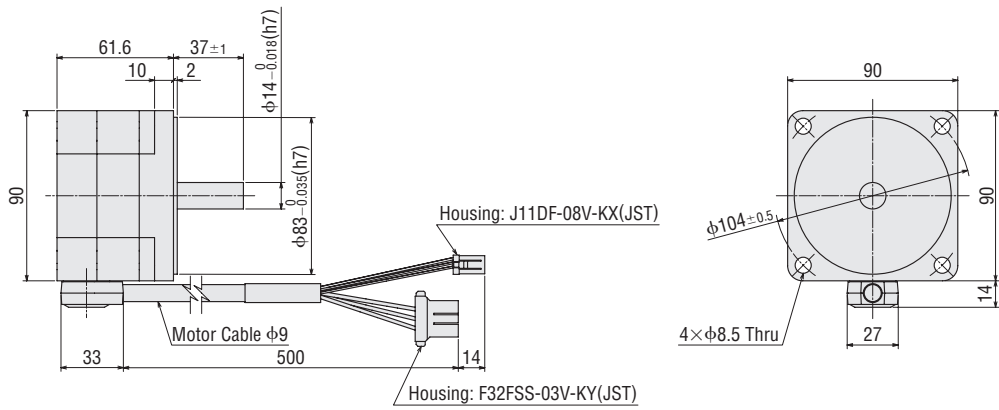

- Cable output in the opposite side of the output shaft

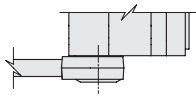

◇ Round Shaft Type • 400 W

BLMR5400K-A ■

Mass: 2.0 kg

- Cable output in the side of the output shaft

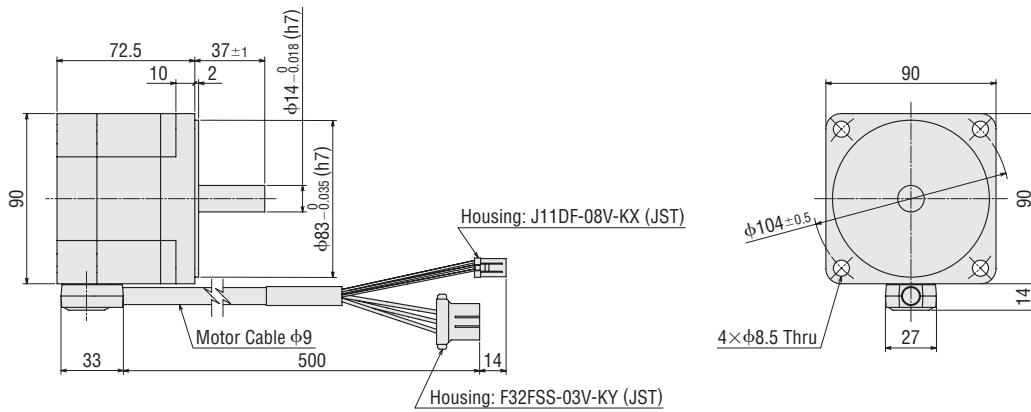

- Cable output in the opposite side of the output shaft

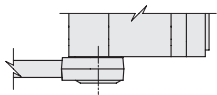

● Electromagnetic Brake Motor

◇ Parallel Shaft Gearhead • 100 W

Product Name	Motor Product Name	Gearhead Product Name	Gear Ratio	L	Mass [kg]
BLMR5100KM-□-■	BLMR5100KM-GFV-■	GFV5G□	10 - 20	45	2.65
			30 - 100	58	3.0

● Cable output in the side of the output shaft

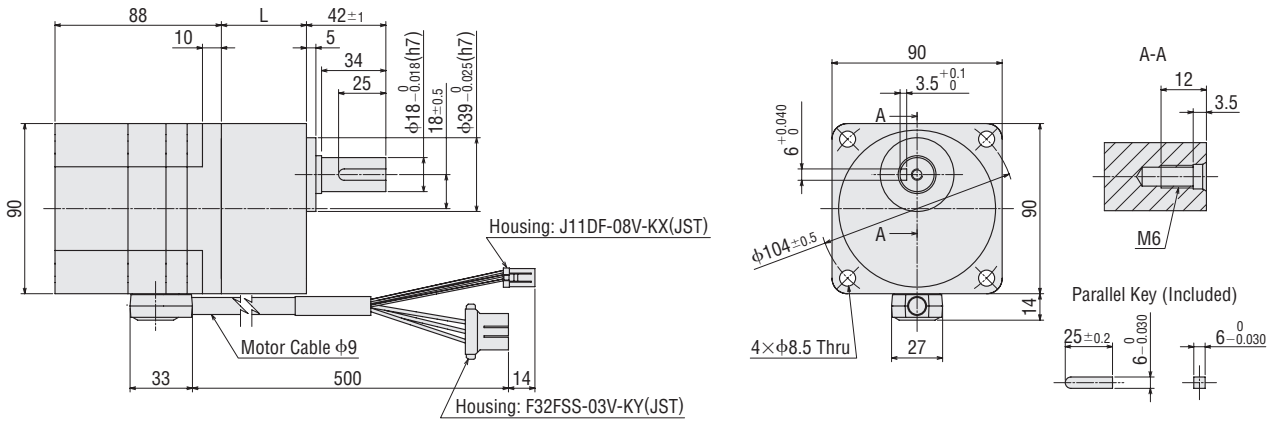

● Cable output in the opposite side of the output shaft

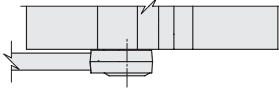

◇ Parallel Shaft Gearhead • 200 W

Product Name	Motor Product Name	Gearhead Product Name	Gear Ratio	L	Mass [kg]
BLMR6200SKM-□-■	BLMR6200SKM-GFV-■	GFV6G□	10 - 20	60	4.1
			30.50	72	4.6
			100	86	5.2

● Cable output in the side of the output shaft

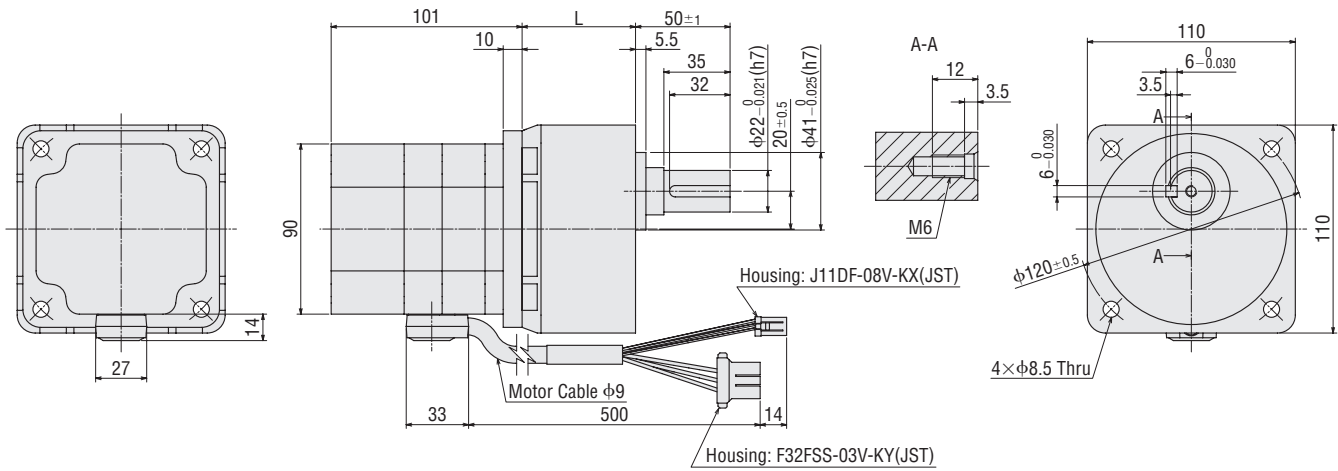

● Cable output in the opposite side of the output shaft

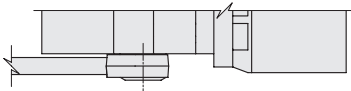

◇ Parallel Shaft Gearhead • 400 W

Product Name	Motor Product Name	Gearhead Product Name	Gear Ratio	L	Mass [kg]
BLMR6400SKM-□-■	BLMR6400SKM-GFV-■	GFV6G□	10 - 20	60	4.6
			30, 50	72	5.1

• Cable output in the side of the output shaft

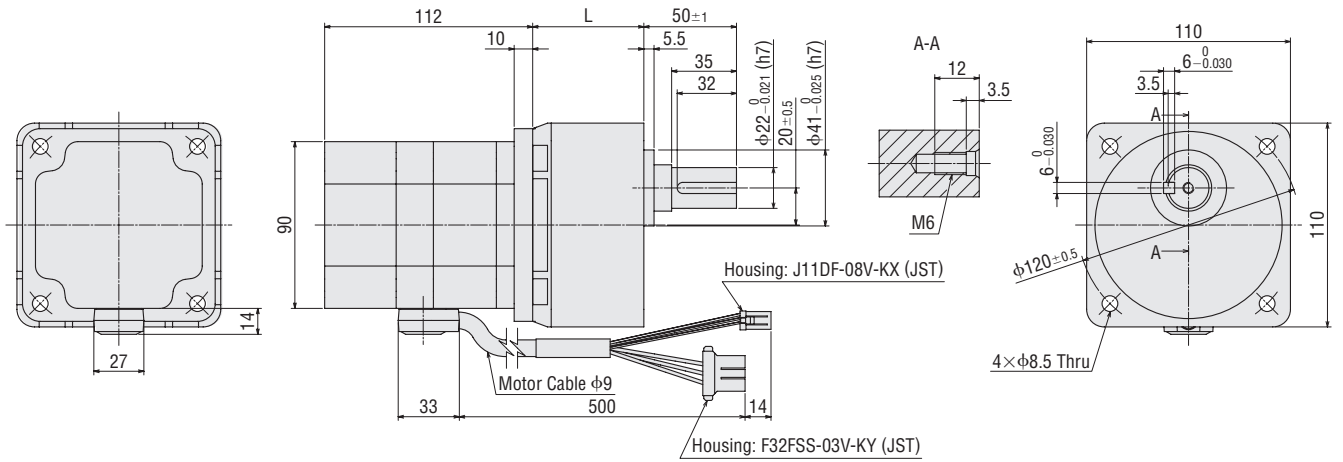

• Cable output in the opposite side of the output shaft

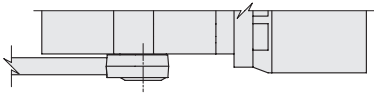

◇Hollow Shaft Flat Gearhead • 200 W

Product Name	Motor Product Name	Gearhead Product Name	Mass [kg]
BLMR6200SKM-□FR-□	BLMR6200SKM-GFV-□	GFS6G□FR	7.0

•Cable output in the side of the output shaft

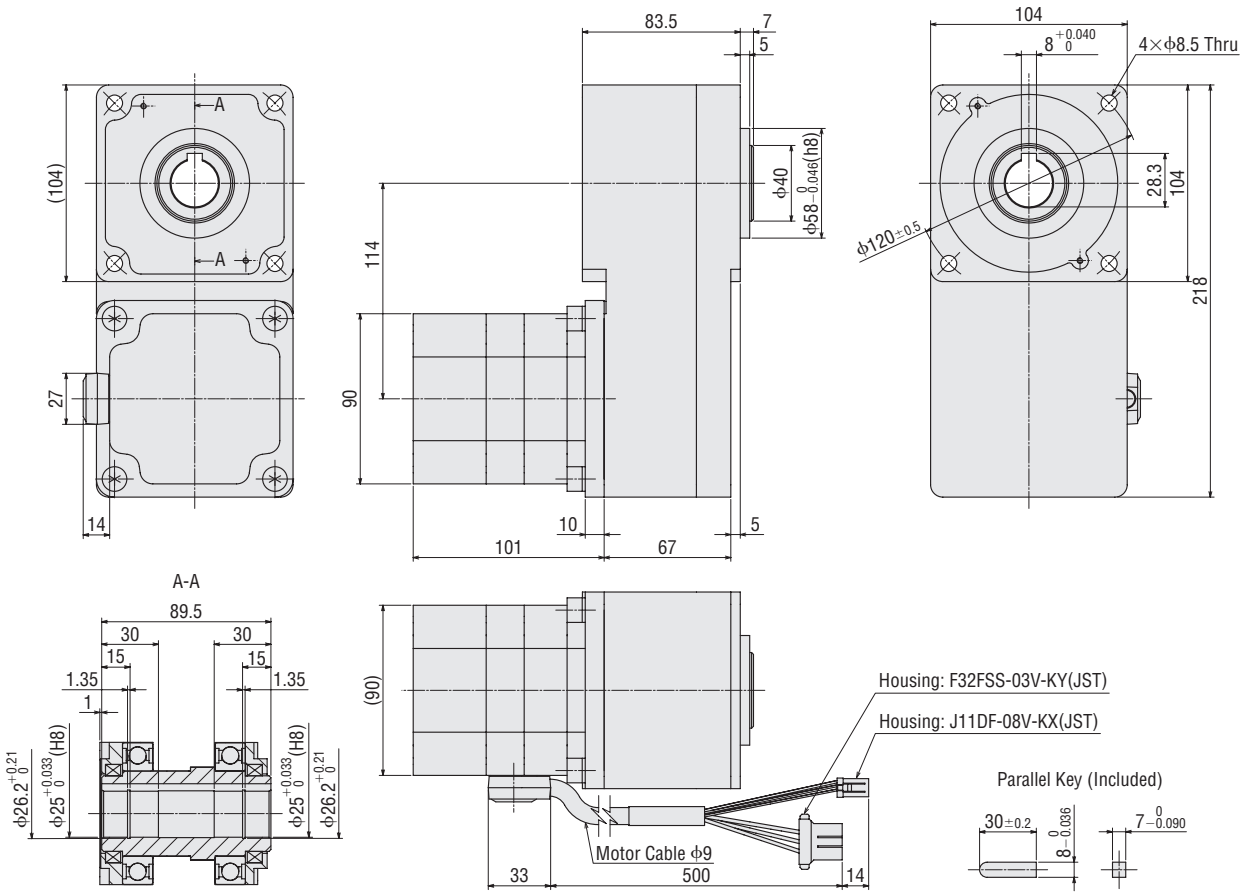

•Cable output in the opposite side of the output shaft

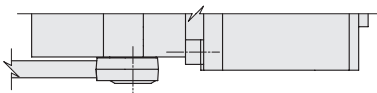

◇Hollow Shaft Flat Gearhead • 400 W

Product Name	Motor Product Name	Gearhead Product Name	Mass [kg]
BLMR6400SKM-□FR-■	BLMR6400SKM-GFV-■	GFS6G□FR	7.5

●Cable output in the side of the output shaft

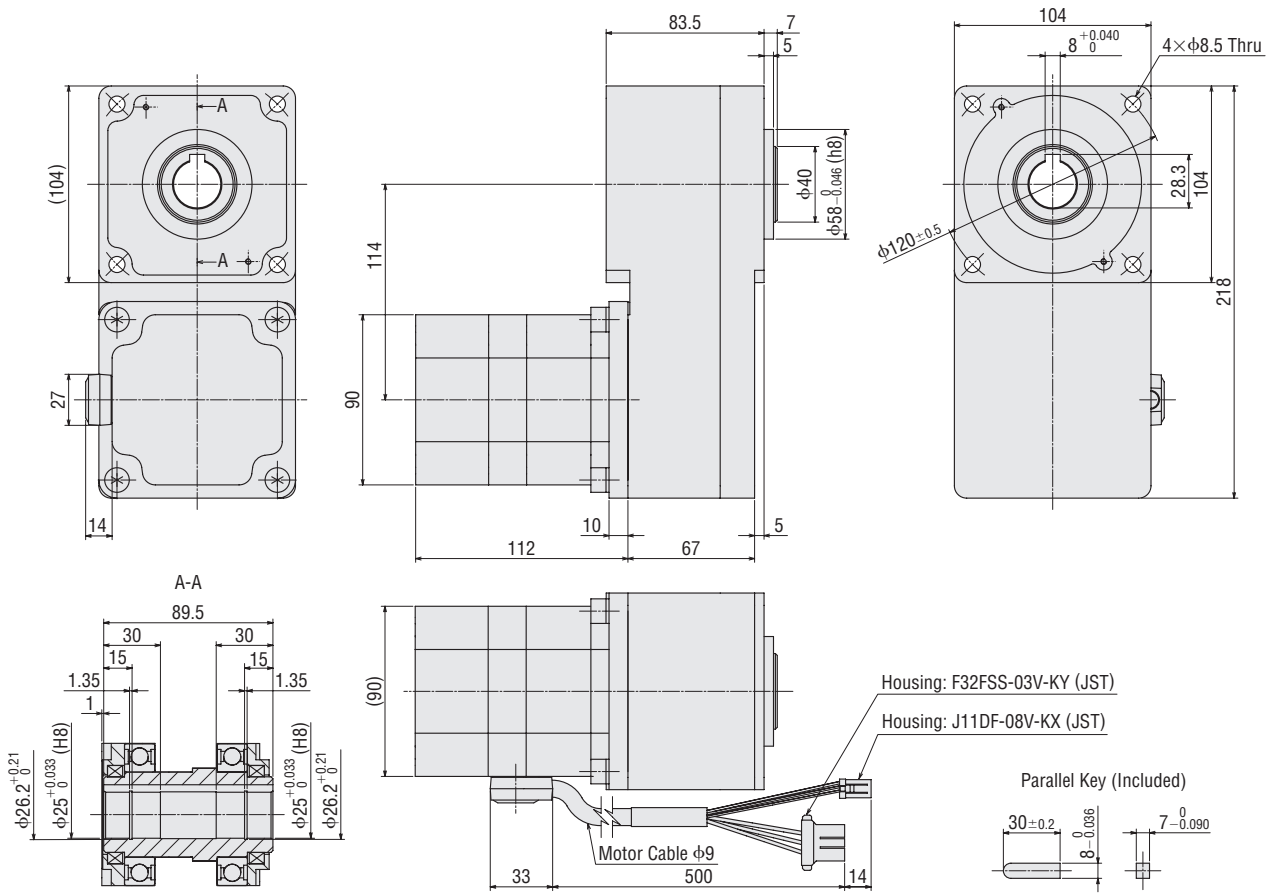

●Cable output in the opposite side of the output shaft

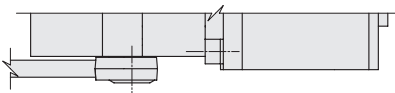

◇ Round Shaft Type • 100 W

BLMR5100KM-A ■

Mass: 1.7 kg

● Cable output in the side of the output shaft

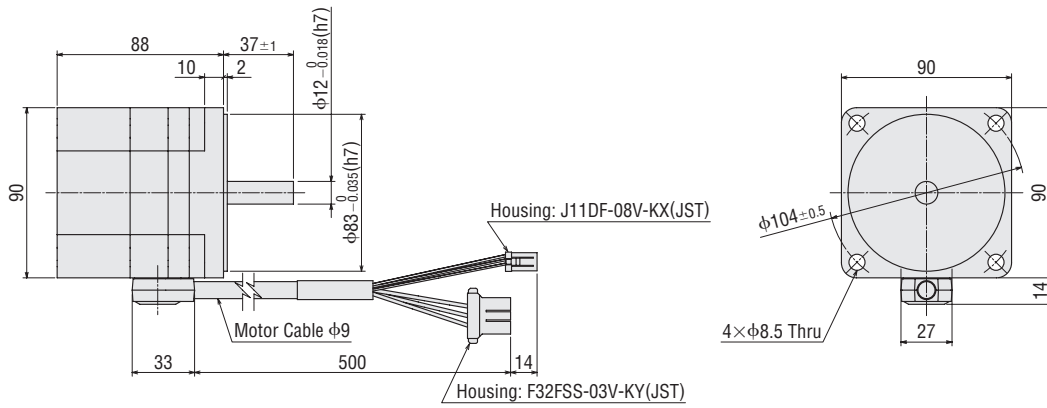

● Cable output in the opposite side of the output shaft

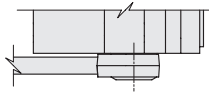

◇ Round Shaft Type • 200 W

BLMR5200KM-A ■

Mass: 2.1 kg

● Cable output in the side of the output shaft

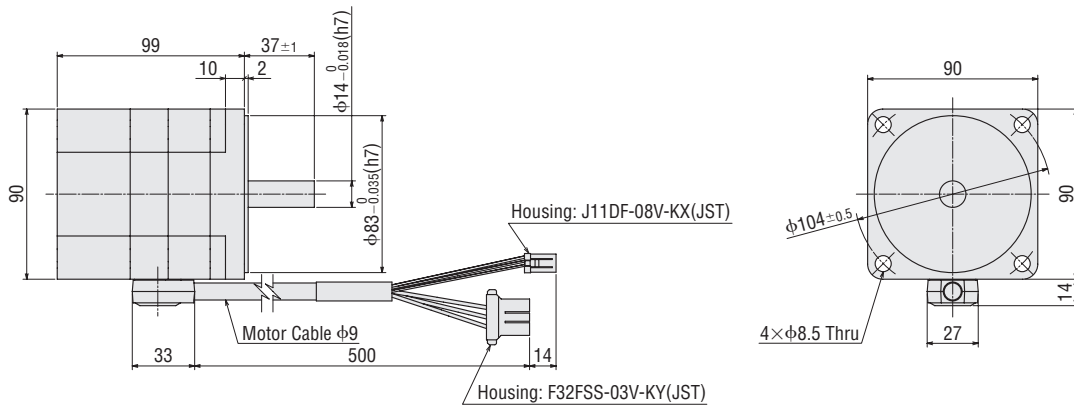

● Cable output in the opposite side of the output shaft

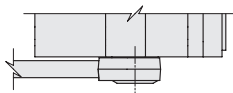

◇ Round Shaft Type • 400 W

BLMR5400KM-A-■

Mass: 2.6 kg

● Cable output in the side of the output shaft

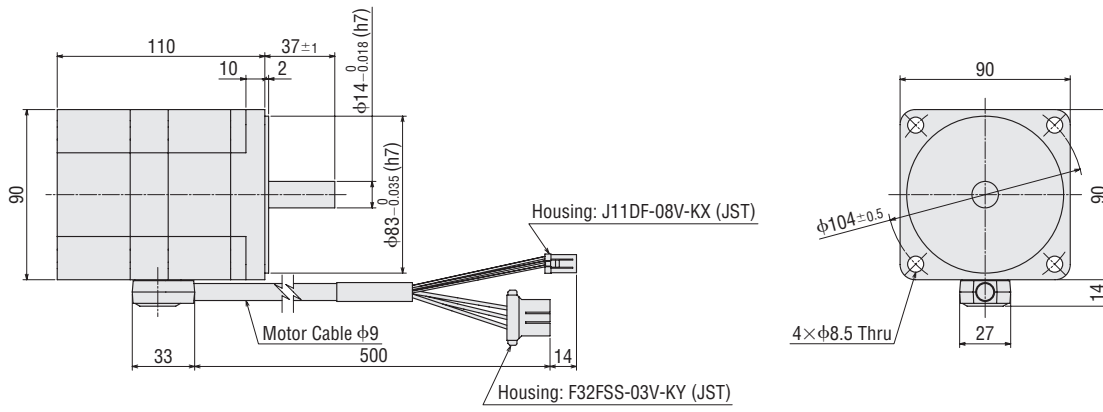

● Cable output in the opposite side of the output shaft

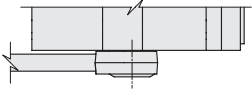

● Driver

BLVD-KRD

Mass: 0.12 kg

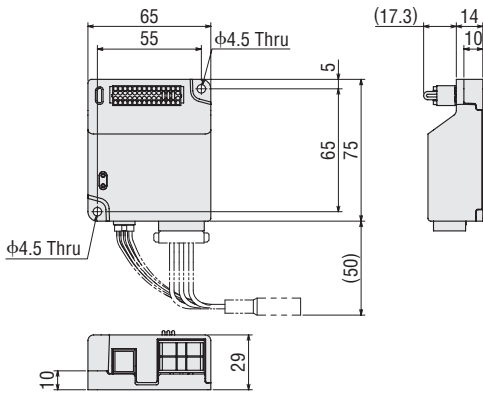

● Connection Cables / Flexible Connection Cables

◇ For 60 W

Product Line	Length L [m]	Product Name	Mass [kg]
Connection cable	0.3	CCM003B1ABF	0.03
	1	CCM010B1ABF	0.09
	2	CCM020B1ABF	0.18
	3	CCM030B1ABF	0.27
Flexible Connection Cable	1	CCM010B1ABR	0.09
	2	CCM020B1ABR	0.18
	3	CCM030B1ABR	0.27

Motor Side

Driver Side

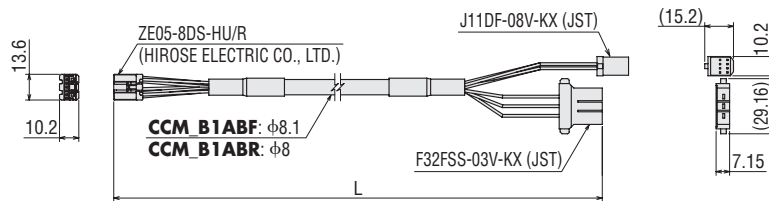

◇ For 100 W, 200 W, and 400 W

Product Line	Length L [m]	Product Name	Mass [kg]
Connection cable	1	CCM010B1AAF	0.13
	2	CCM020B1AAF	0.25
	3	CCM030B1AAF	0.37

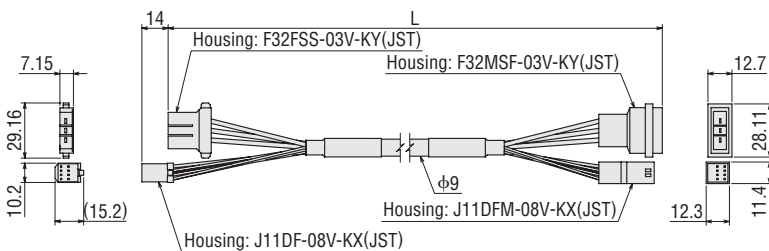

● Power Supply Cable

LC03D06A

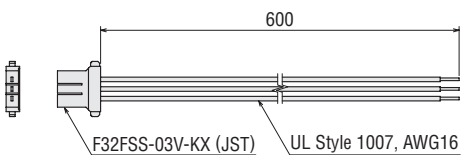

Installation Screw Dimensions

L2 is the dimensions when a flat washer and spring washer are installed on the head side of the screw.

Parallel Shaft Gearhead

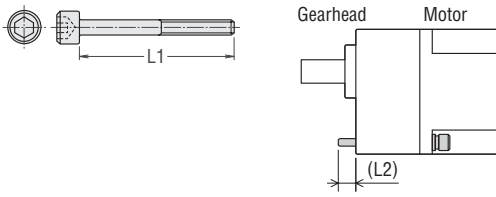

Product Name	Gear Ratio	Installation Screws		L2 [mm]
		Type of Screw	L1 [mm]	
GFV4G □	5 - 20	M6	60	8
	30 - 100		65	8
GFV5G □	10 - 20	M8	70	11.5
	30 - 100		85	13.5
GFV6G □	10 - 20	M8	85	11
	30, 50		100	14
	100		110	10
BLMR260HK -□ CS	5 - 20	M4	60	10

- Installation screws: 4 flat washers and spring washers are included.
The material of the installation screws is stainless steel.

Hollow Shaft Flat Gearhead

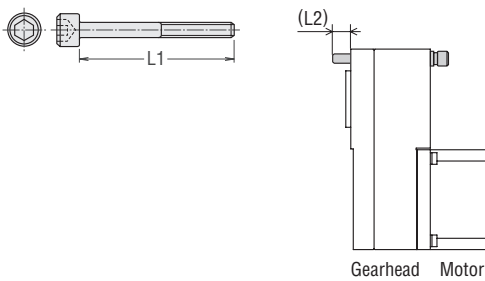

Product Name	Gear Ratio	Installation Screws		L2 [mm]
		Type of Screw	L1 [mm]	
GFS4G □ FR	5 - 200	M6	70	14
GFS5G □ FR	10 - 200	M8	90	21
GFS6G □ FR	10 - 100	M8	100	13

- Installation screws: 4 flat washers, spring washers and hexagonal nuts are included.
No hexagonal nuts are included with the **GFS6G**□**FR**.

● A number indicating the gear ratio is specified where the box □ is located in the product name.

■ Calculation of Permissible Radial Load of Hollow Shaft Flat Gearhead

The permissible radial load calculation formula differs depending on the mechanism.

◇ If One Side of the Load Shaft is Not Supported by the Bearing Unit

Radial load is the most severe mechanism. The recommended load shaft is the stepped type.

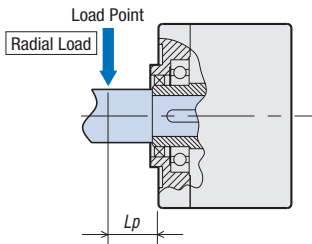

F_0 [N] : Permissible radial load on flange-installation surface

L_p [mm] : Distance from flange-installation surface to radial load point

B [mm] : Distance from flange-installation surface to bearing unit

Product Name	Permissible Radial Load W [N]
GFS4G□FR	$W [N] = \frac{40}{40+L_p} \times F_0 [N]$
GFS5G□FR	$W [N] = \frac{50}{50+L_p} \times F_0 [N]$
GFS6G□FR	$W [N] = \frac{60}{60+L_p} \times F_0 [N]$

◇ If One Side of the Load Shaft is Supported by the Bearing Unit

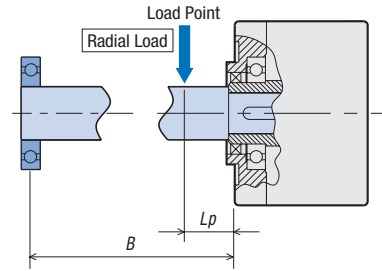

Product Name	Permissible Radial Load W [N]
GFS4G□FR GFS5G□FR GFS6G□FR	$W [N] = \frac{B}{B-L_p} \times F_0 [N]$

Product Name	Speed	Gear Ratio	F_0 [N]
GFS4G□FR	At 1 - 3000 r/min	5, 10	1000
		15 - 200	1500
	At 4000 r/min	5, 10	910
		15 - 200	1370
GFS5G□FR	At 1 - 3000 r/min	10	1080
		15, 20	1550
		30 - 200	1800
	At 4000 r/min	10	980
		15, 20	1430
		30 - 200	1680
GFS6G□FR	At 1 - 3000 r/min	10	1430
		15, 20	1960
		30 - 100	2380
	At 4000 r/min	10	1320
		15, 20	1810
		30 - 100	2210

● A number indicating the gear ratio is specified where the box □ is located in the product name.

Cables / Peripheral Equipment (Sold separately)

Cables

● Cable System Configuration

◇ 60 W Type

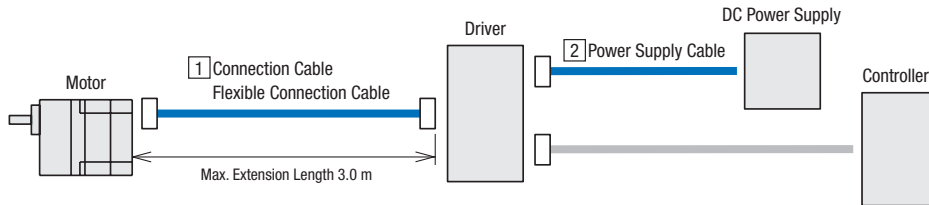

◇ 100 W, 200 W, and 400 W Type

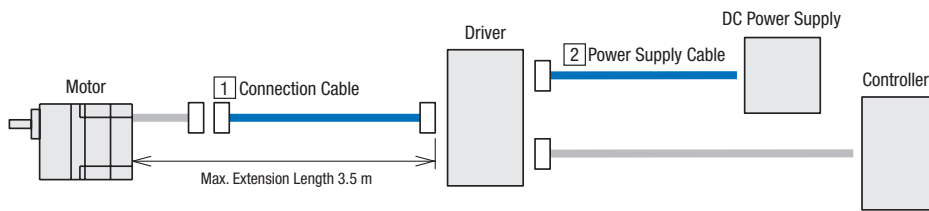

1 Connection Cables / Flexible Connection Cables

These cables are used to connect the motor and the driver.

- Keep the overall cable within 3.5 m (3.0 m for the 60 W type).
- Use the flexible connection cable in applications where the cable is bent and flexed repeatedly.



- Product Line → Page 16
- Dimensions → Page 40

2 Power Supply Cable

These cables are used to connect the driver and the DC power supply.



- Product Line → Page 16
- Dimensions → Page 40

■ Mounting Bracket for Motor and Gearhead

A convenient mounting bracket for installing and fixing parallel shaft gearheads and round shaft types.



● Product Line

Product Name	Applicable Product
SOL2M4F	BLMR260 (CS geared motor, round shaft type)
SOL4M6F	BLMR460 (Parallel shaft gearhead)
SOL5M8F	BLMR5100 BLMR5200, BLMR5400 (Round shaft type)
SOL6M8F	BLMR6200, BLMR6400 (Parallel shaft gearhead)

Note

● A hollow shaft flat gearhead cannot be used.

■ Flexible Couplings

A clamp type coupling for connecting the motor and gearhead shaft.

Couplings that can be used with parallel shaft gearheads and round shaft types are available.

● Couplings can also be used on round shaft types.

Select a coupling with the same inner diameter as the motor shaft diameter.



● Product Line

Applicable Product	Load Type	Coupling Type
BLMR460	Uniform Load	MCL40 Type
	Impact Load	MCL55 Type
BLMR5100	Uniform Load	MCL55 Type
	Impact Load	
BLMR6200 BLMR6400	Uniform Load	MCL65 Type
	Impact Load	

Orientalmotor

These products are manufactured at plants certified with the international standards **ISO 9001** (for quality assurance) and **ISO 14001** for systems of environmental management).

Specifications are subject to change without notice. This catalogue was published in January 2024.

ORIENTAL MOTOR (EUROPA) GmbH

European Headquarters

Schießstraße 44
40549 Düsseldorf, Germany
Tel: 0211 5206700 Fax: 0211 52067099

Spanish Office

C/Caléndula 93 - Ed. E - Miniparc III
28109 El Soto de La Moraleja,
Alcobendas (Madrid), Spain
Tel: +34 918 266 565

ORIENTAL MOTOR (UK) LTD.

UK Headquarters

Unit 5, Faraday Office Park,
Rankine Road, Basingstoke,
Hampshire RG24 8AH, U.K.
Tel: +44 1256 347090 Fax: +44 1256 347099

ORIENTAL MOTOR SWITZERLAND AG

Switzerland Headquarters

Badenerstrasse 13
5200 Brugg AG, Switzerland
Tel: +41 56 560 50 45 Fax: +41 56 560 50 47

ORIENTAL MOTOR ITALIA s.r.l.

Italy Headquarters

Via XXV Aprile 5
20016 Pero (MI), Italy
Tel: +39 2 93906346 Fax: +39 2 93906348

ORIENTAL MOTOR (FRANCE) SARL

France Headquarters

56, Rue des Hautes Pâtures
92000 Nanterre, France
Tel: +33 1 47 86 97 50 Fax: +33 1 47 82 45 16

Customer Service Center

(Support in German & English)

00800 22 55 66 22*

Mon - Thu: 08:00 - 16:30 CET

Friday: 08:00 - 15:00 CET

*Free Call Europe

info@orientalmotor.de

WWW.ORIENTALMOTOR.EU

EN | DE | UK | IT | FR | ES